



OWNER'S MANUAL

CLX OnLine Residual Chlorine Monitor

HF scientific
3170 Metro Parkway
Ft. Myers, FL 33916
Phone: 239-337-2116
Fax: 239-332-7643
Toll Free: 888-203-7248
EMail: HFInfo@Watts.com
Website: www.hfscientific.com

DECLARATION OF CONFORMITY

Application of Council Directive
Standards to Which Conformity is Declared:

Product Safety – Tested and passed:

ETL (tested to ANSI/ UL61010-1-2004)

Tested and passed ETL (tested to CAN/CSA C22.2 No.61010.1- 2nd Edition, dated July 12, 2004)

Emmissions & Immunity – Tested and passed:

EN61326-1: 2006

Compliance Testing

- Vibration to EN 60945 - Section 8.7
- Dry Heat to EN 60945 – Section 8.2
- Damp Heat to Lloyds register Test Spec. No. 1 Section 14
- Low Temperature to EN 60945 – Section 8.4.2
- 22 Degree Tilt operation

Manufacturer's Name: HF scientific, inc.

Manufacturer's Address: 3170 Metro Parkway, Fort Myers, Florida 33916-7597

Importer's Name:

Importer's Address:

Type of Equipment: Chlorine Process Analyzer

Model No: CLX

I, the undersigned, hereby declare that the equipment specified above conforms to the above Directive and Standard

Place: Fort Myers, Florida USA

Date: 18 January 2008

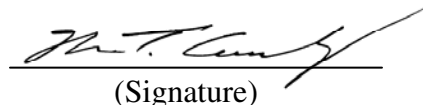

(Signature)

Rowan T. Connelly, General Manager

Table of Contents

Section	Page
Specifications	1
1.0 Overview	2
1.1 Unpacking and Inspection of the Instrument and Accessories	2
1.2 The Display	3
1.3 The Touch Pad	3
2.0 Safety	4
2.1 Symbols Used In CLX	4
3.0 Theory of Operation	5
4.0 Installation and Commissioning	6
4.1 Mounting & Site Selection	6
4.2 Plumbing	7
4.3 Electrical Connections	8
4.3.1 Power	9
4.3.2 RS-485	9
4.3.3 Relays.....	10
4.3.4 4-20 mA	10
4.3.5 RS-485/4-20 mA cable Ferrite.....	10
4.4 Installing Reagents	10
5.0 Operation	11
5.1 Routine Measurement	11
5.2 Security Access Feature.....	12
5.3 The White LED.....	12
6.0 Instrument Calibration	13
6.1 Slope (gain) Calibration Procedure	13
6.2 Zero (offset) Calibration Procedure	14
6.3 Restore Factory Settings	14
7.0 Instrument Configuration (CONFIG mode)	15
7.1 Setting the 4-20 mA.....	15
7.2 Configuring the Error Level.....	16
7.3 Configuring the RS-485 Port	16
7.4 Configuring the Alarms	17
7.4.1 Alarm 1	17
7.4.2 Alarm 2	18
7.5 Enabling the Security Access.....	18

Table of Contents (continued)

Section	Page
7.6	Extended Settings.....18
7.7	Units of Measurement.....19
7.8	Averaging and Filtering19
7.9	LCD Backlight Brightness.....20
7.10	RS- 485 Parameters.....20
7.11	Cycle Time21
7.12	Water Conservation21
7.13	4 mA Adjustment.....22
7.14	20 mA Adjustment.....22
8.0	Additional Features and Options23
8.1	Backlit LCD.....23
8.2	RS-485 Output23
8.2.1	HF Online Communication.....23
8.2.2	Simple Communication23
8.2.3	Modbus Communication.....24
8.3	Remote Panel Meter.....24
8.4	Desiccant Cartridge.....24
9.0	Troubleshooting25
9.1	CLX Fault Detection.....25
9.2	Setting Flow Rate.....26
9.3	Clearing Faults26
9.4	Reagent Clogs26
9.5	Diagnostic Chart27
9.6	Technical and Customer Assistance27
10.0	Routine Maintenance.....28
10.1	Maintenance Schedule28
10.2	Replacing or Installing the Reagents30
10.3	Check Valve Flushing Kit31
10.4	Cuvette Change32
10.5	Instrument Storage32
10.6	Cleaning the CLX32
11.0	Accessories and Replacement Parts List33
12.0	Warranty34

Specifications

Measurement Range	0 – 10.00 mg/L (PPM)
Accuracy	±5% of reading or ±0.03 mg/L (PPM) whichever is greater for range of 0-6.0 mg/L(PPM) ±10% of reading from 6.01-10.00 mg/L (PPM)
Resolution	0.01 mg/L (PPM)
Cycle Time	Adjustable; 110 seconds to 10 minutes (600 seconds) Note: the system defaults to 2.5 minutes
Display	Multi-Line Liquid Crystal Backlit Display
Alarms	Two Programmable, 120-240VAC 2A Form C Relay
Analog Output	Powered 4-20 mA, 600 Ω drive, isolated
Communications Port	Bi-directional RS-485 with Modbus
Water Pressure	Integral pressure regulator 0.34 bar(5.0 PSI) to 10.3 bar (150 PSI.)
Flow Rate to Waste	200 – 400 ml/min.
Operating Temperature	0°C – 40°C (32°F – 104°F)
Wetted Materials	PVC, Borosilicate Glass, Reslyn (FFKM), Viton [®] (FKM), Polypropylene, Stainless Steel, Acetal, Noryl [®] , Silicone
Sample Temperature Range	0°C – 40°C (32°F – 104°F)
Power Supply	100 – 240 VAC, 47 – 63 Hz, 150VA
Insulation Rating	Double Insulated, Pollution Degree 2, Overvoltage Category II
Environmental Conditions	Not recommended for outdoor use. Altitude up to 2000 meters Up to 95 % RH (non-condensing)
Enclosure Rating	Designed to meet IP 66 /NEMA 4X
Regulatory Compliance And Certifications	CE Approved, ETL listed to UL 61010-1-2004 & ETL Certified to CSA 22.2 No. 61010.1 2 nd edition dated July 2004
Shipping Weight	3.9 kg (8.6 lbs.) Reagents Shipped Separately
Shipping Dimensions	406 mm X 406 mm X 241 mm (16"X 16" X 9 ½")
Warranty	1 Year from date of shipment

1.0 Overview

The CLX Online Chlorine Analyzer allows for the reading of chlorine levels of process water on-line. The CLX has been designed to meet the design criteria specified by Standard Methods for the Examination of Water and Wastewater (21th Edition) Method 4500-Cl G. DPD Colorimetric Method. The CLX uses a 515nm LED as the measurement light source.

Every effort has been made to ensure the accuracy of this manual. Due to the continuous development and improvement of all instrumentation, there may be slight differences between this manual and the instrument received. Therefore, no legal claims can be made against any discrepancies herein. The latest version of the manual can be downloaded from www.hfscientific.com.

1.1 Unpacking and Inspection of the Instrument and Accessories

The table below indicates the items in the shipment.

Item	Quantity
CLX Analyzer	1
Instruction Manual	1
Mounting Kit	1
Tubing/Cuvette Kit: 8 black "B" tubes, 2 Cap Assemblies, 1 replacement cuvette	1
In-Line Strainer Kit	1
Check Valve Flushing Kit	1

Remove the instrument from the packing carton. Carefully inspect all items to ensure that no visible damage has occurred during shipment. If the items received do not match the order, please immediately contact the local distributor or the HF scientific Customer Service Department.

1.2 The Display

Figure 1 illustrates all the items that can appear on the display. The upper row of the display (1) is used for reporting the chlorine levels and to provide user guidance in the customer setting routine. The lower row of the display (2) is used to communicate error messages (message queue) and provide user guidance. The display has two icons (3) that are used to indicate the use of access code and offset mode. In addition, mode arrows (4) are used to indicate the current instrument operating mode; AUTO (normal operation), CAL (calibration) and CONFIG (configuration).

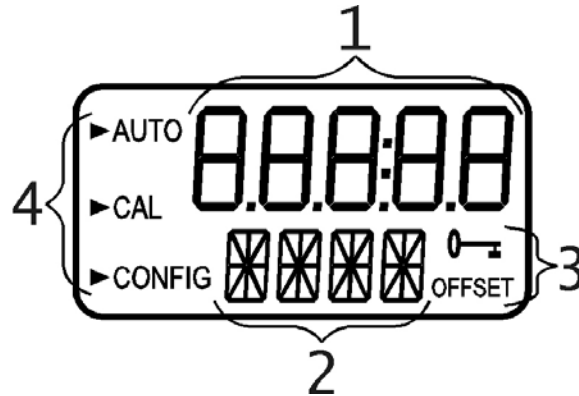

Figure 1: Display used in the instrument.

1.3 The Touch Pad

Figure 2 illustrates the touch pad. The touch pad has six buttons: **PRIME**, **SERVICE**, **MODE/EXIT**, \leftarrow , \blacktriangle and \blacktriangledown

The **MODE/EXIT** button is used to cycle between the three operational modes of the instrument: **CAL**, **CONFIG**, and **AUTO** (Measurement) mode. The \leftarrow button enters the option or mode that is highlighted or chosen. The \blacktriangle and \blacktriangledown buttons are used to change settings.

The **PRIME** and **SERVICE** buttons are dedicated controls. The **PRIME** will start 75 reagent pump pulses to prime the tubing after a change or addition of reagent bottles. The **SERVICE** button will drain the instrument and hold all operations until either the **SERVICE** button is pushed again or the power is reset. This button should be used while changing the tubing, the measurement cuvette or reagent bottles.

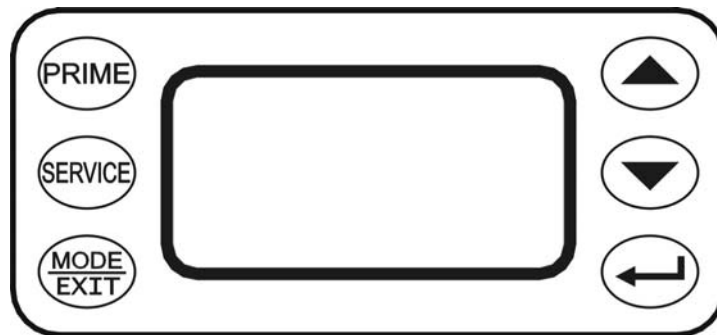

Figure 2: The CLX touch pad.

2.0 Safety

This manual contains basic instructions that must be followed during the commissioning, operation, care and maintenance of the instrument. The safety protection provided by this equipment may be impaired if it is commissioned and/or used in a manner not described in this manual. Consequently, all responsible personnel must read this manual prior to working with this instrument.

In certain instances “**Notes**”, or helpful hints, have been highlighted to give further clarification to the instructions. Refer to the *Table of Contents* to easily find specific topics and to learn about unfamiliar terms.

2.1 Symbols Used In CLX

Standard IEC symbols are used on the high voltage cover.



ISO 3864, No. B.3.6 Caution, risk of electric shock.

This symbol indicates that hazardous voltages may be present under this cover



ISO 3864, No.B3.1 Caution refer to accompanying documents.

This symbol is reminding you to read the sections in the manual referring to the electrical connections, and potential hazards.

3.0 Theory of Operation

The CLX has two solenoid valves, one for sample water (FLOW) and one for draining of the cuvette (PURGE). A third solenoid, along with four check valves forms a reagent pump. Sample water flow is controlled by the FLOW solenoid valve. The PURGE solenoid valve is used to empty the cuvette in the measurement chamber.

The measurement chamber consists of a sample inlet, a purge drain, and an overflow. The reagent is added from the check valves integrated into the lower portion. A green LED provides the 515 nm source lamp, a red LED is used for sample level and flow measurement. A single detector is located 180 ° from the green LED. A replaceable glass cuvette separates the LEDs from the detector and maintains the measurement path length. Sample water flows in the inlet at the bottom, through the measurement cuvette and out through an overflow drain. This flow is used to both fill the cuvette and flush the system.

The reagents are dispensed from two replaceable bottles. One bottle has a buffer to control the pH; the second has an indicator that contains the DPD, which produces color when chlorine is present in the sample. The degree of color is dependant on the amount of chlorine in the sample water.

The measurement chamber is open to view operations. A white LED backlights the chamber for a clearer view. The white LED will flash to attract attention in the case of a warning or failure. Most warnings and failures are also displayed on the screen. To prevent interference, the white LED is turned off during measurements.

During normal operation the CLX will run through a timed cycle. A simplified cycle will consist of the following sequences:

- Flushing – continuous sample flow
- Purging – PURGE valve opens
- Zeroing – no flow with cuvette full
- Adding Reagents – one pulse of the reagent pump
- Mixing with sample – sample flow pulses in
- Reading resulting sample – no flow with cuvette full
- Purging – PURGE valve opens to remove reacted sample

The cycle above is simplified and does not describe all the actions and testing that occurs. The CPU continuously diagnoses the entire system for correct operation and sample water flow. If an error occurs, a message is posted to the message queue on the LCD screen.

The reagent is added by a single pulse of the reagent solenoid. When the reagents require replacement, the **PRIME** button is pushed to bring new reagents into the system. During **PRIME** the reagent solenoid is pulsed several times to draw fluid from the two reagent bottles and fill the tubes with new reagent. A complete **PRIME** takes less than a minute.

The **SERVICE** button empties the cuvette, stops the flow of sample water, and clears any errors. This provides a convenient way to replace reagents and the measurement cuvette. If more extensive servicing is performed, all power to the CLX should be removed. If the CLX is to be turned off, it is recommended that the instrument be placed in **SERVICE** mode before removing power. This ensures that the cuvette is emptied and the flow is off.

4.0 Installation and Commissioning

Prior to use for the first time, one of the reagents (the indicator) will have to be mixed. Refer to section [10.2 Replacing or Installing the Reagents](#).

4.1 Mounting & Site Selection

The instrument is designed for wall mounting. If wall mounting is not practical, the instrument can be mounted on any suitable level surface. Choose a location that is easily accessible for operation and service and ensure that the front display rests at eye level. Consideration must be made the plumbing connections. The overall mounting dimensions of the instrument are shown in Figure 3.

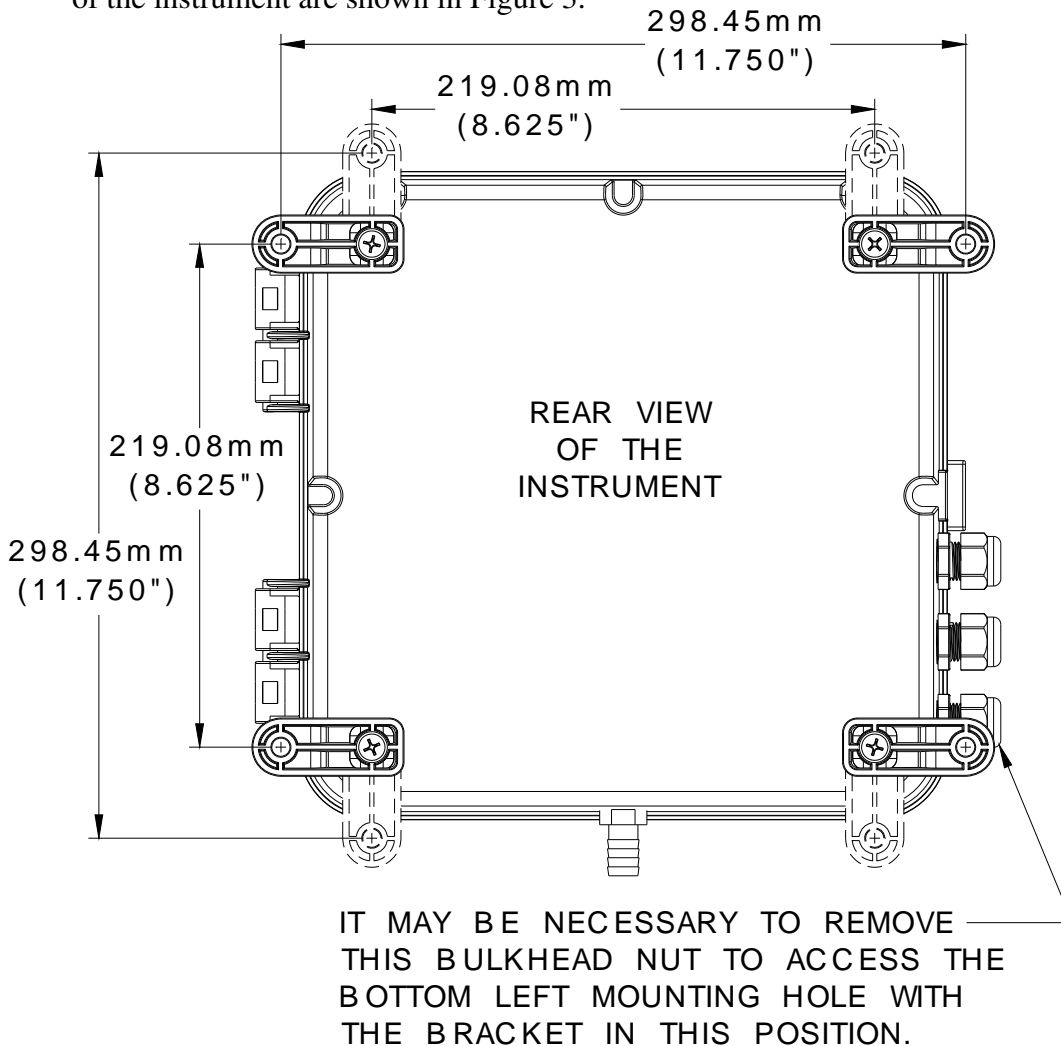

Figure 3: Overall Mounting Dimensions of the Instrument

It is critical that the instrument be mounted as close as possible to the sampling point to ensure a quick response time (within 2-3 meters (6-10 ft) of the sampling point).

The provided mounting feet will need to be installed with the provided screws. These can be rotated as shown above. Suggested mounting screws are up to M6 (1/4").

4.2 Plumbing

The recommended plumbing for the instrument is shown in Figure 4. The instrument is designed to require very little head pressure to operate, but will need around 0.34 bar (5 PSI). The maximum pressure for proper operation should not exceed 10.3 bar (150 PSI). The maximum allowable fluid temperature is 40°C (104°F).

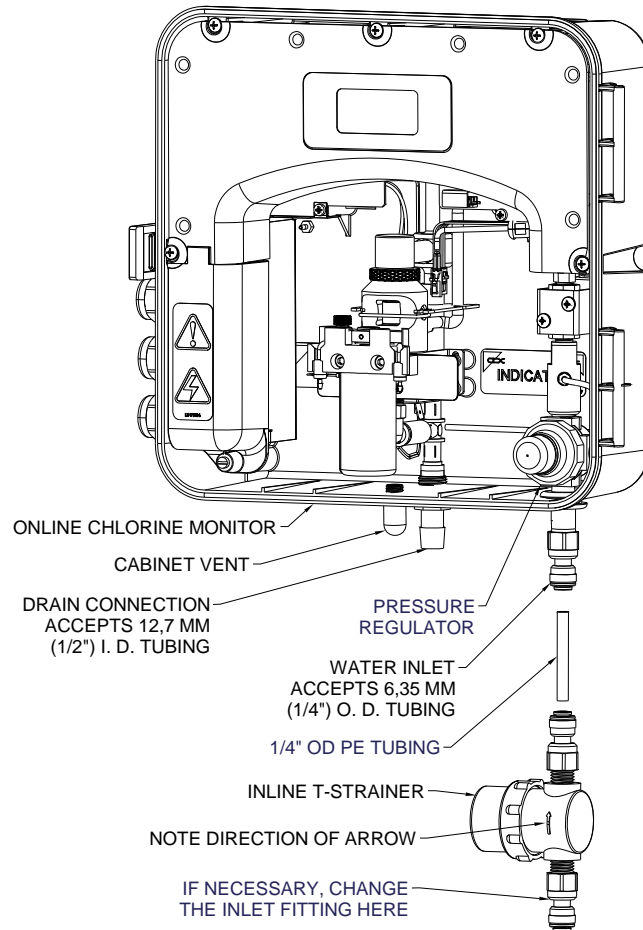

Figure 4: Recommended Plumbing for the Instrument

The supplied T-strainer should always be used to prevent clogging of the instrument. 1/4" quick connect fittings are supplied on the T strainer. If a pipe fitting change is required, this adaptation should be made at the T-strainer, not the instrument. Opaque tubing is recommended be used if the tubing will be exposed to sunlight, to prevent algae growth. Please note that the supplied connectors are compatible with 1/4" O.D. semi-rigid or rigid tubing.

The instrument is equipped with an internal cabinet drain (vent) to prevent damage in the event of a tubing failure.

The drain tubing connects to a hose barb. The rated tubing size is 1/2" ID tubing. It is recommended that opaque tubing be used to prevent algae growth. Keep this tubing as short as possible. This drain must be kept open to the atmosphere.



The fluid waste from drain connection of this instrument contains reagents diluted with large quantities of sample water. HF scientific recommends that operators check with local authorities concerning proper disposal of waste fluids. This waste fluid must NEVER be reintroduced into the incoming water stream.

A 1/2 " ID tubing can be placed over the cabinet vent to redirect accidental spills of reagent to a suitable container.

4.3 Electrical Connections

All of the electrical connections to the instrument are made at the termination area which is located on the left side of the instrument. Remove the high voltage cover by loosening the captive screw. Refer to figure 5. The connections are labeled and are self-descriptive (see Figure 5). Please follow all local and government recommendations for installation of electrical connections to and between the instrument and other peripheral devices.

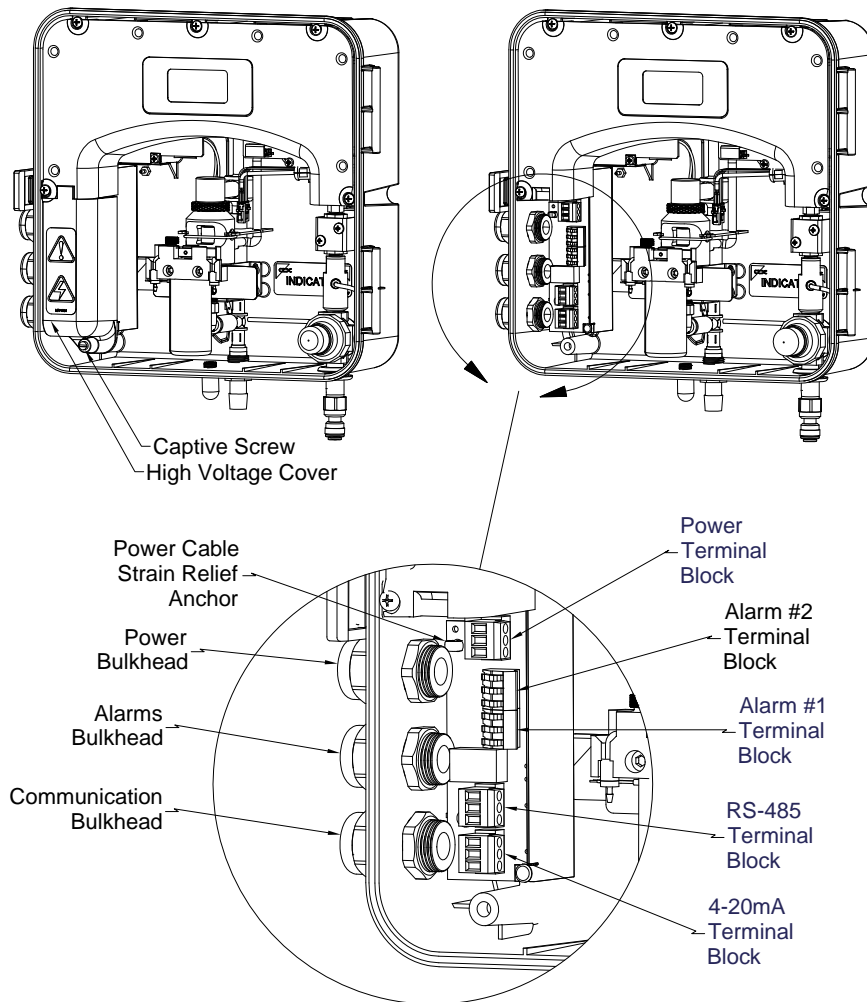

Figure 5: Electrical Connections for the Instrument

Plugs are inserted into the RS-485 and 4-20mA cable bulkheads when shipped, to ensure a watertight seal. These plugs should be removed and discarded when cabling to either of these connections.

The power cable bulkhead will accept cable diameters from 5.8mm (.230 in.) up to 10 mm (.395 in.). All terminals are designed to accept wires in the range of 14-28 AWG. All wires should be stripped to a length of 6 mm (¼”). A strain relief strap is provided to reduce tension on the power terminals.

It is the user’s responsibility to assure that a watertight seal is maintained after the CLX has been wired for operation. If any of the bulkheads are not tightened properly around a cable or plug, the ratings of the instrument will be jeopardized and there is a possibility of creating a shock hazard.



Only qualified electricians should be allowed to perform the installation of the instrument as it involves a line voltage that could endanger life.

4.3.1 Power

The instrument is equipped with 100-240 VAC, 47-63 Hz power supplies requiring 150VA; please verify that the line voltage falls within these specifications. It is recommended that a circuit breaker be placed prior to the power connection to allow for service. For safety it is recommended that the connection be less than 2 meters (six feet) from the instrument. While making connections, refer to [Figure 5](#).

The CLX is intended for cord connection with a three wire non-locking grounded power cord, however ridged or flexible conduit connections can be used. A power cord can be purchased separately from the factory (Catalog No. 20779S). **The CLX is not supplied with a power cord.** If the CLX is to be used in the U.S. or Canada the power cord must be UL Listed & CSA Certified. Please consult all local electrical codes for proper connection.

The connection block is marked N for Neutral and L for line the third symbol indicates a secure earth ground. The green removable terminal block is suitable for wire gauges 18 to 12 AWG.

4.3.2 RS-485

The RS-485 half-duplex (2-wire) digital interface operates with differential levels that are not susceptible to electrical interferences. This is why cable lengths up to 3000 ft can be implemented. The last device on each bus may require terminating with a 120 ohm resistor to eliminate signal reflection on the line. Do not run RS-485 cables in the same conduit as power. Set-up of the RS-485 is covered in [7.3 Configuring the RS-485 Port](#)

To prevent damage to the instrument, ensure that power is disconnected prior to making connections. For ease of connecting, remove the plug-in terminal block. Connections are labeled beside this termination on the PC board.

The recommended cable is 22 AWG shielded twisted pair. The grey terminal block is removable to assist in making connections.

4.3.3 Relays

The Alarm 1 and Alarm 2 relays are mechanical relays rated at 240 VAC 2A. Please note that the relays are labeled NO (Normally Open), NC (Normally Closed) and C (Common). As these alarms are configured fail-safe, the normal condition is with power applied to the CLX and in a non-alarm condition. Operation of these alarms is covered in section [7.4 Configuring the Alarms](#).

The lever operated terminal blocks are rated for wire gauges 28-14.

4.3.4 4-20 mA

The 4-20 mA output is driven by a 15 VDC power source and can drive recorder loads up to 600 ohms. Transformer isolation is provided on the CLX. Do not run 4-20 mA cables in the same conduit as power. Operation of this output is covered in section [7.1 Setting the 4-20 mA](#).

To prevent damage to the instrument, and for general safety ensure that power is disconnected to the CLX prior to making any connections. Polarities of the connections are labeled beside this termination on the PC board.

The recommended cable is 22 AWG shielded twisted pair. To prevent ground loops, connect the shield at **either** the CLX or at its destination, but not both. The grey terminal block is removable to assist in making connections.

The 4-20mA is factory calibrated. An adjustment is available on the 4-20mA in sections [7.13](#) and [7.14](#). In addition to making adjustments, these menus output continuous 4 mA or 20 mA and can be used as a signal test. Remember that the configuration mode will timeout after 15 minutes.

4.3.5 RS-485/4-20 mA cable Ferrite

To meet IEC requirements for RF radiated immunity a clamp-on type ferrite is supplied in the accessory kit. It should be placed on the RS-485 or 4-20 mA cable outside, as close as possible to the CLX. If both outputs will be used, an additional ferrite will be needed and can be ordered from HF scientific Catalog number 24560.

4.4 Installing Reagents

The CLX will require that two reagents be installed prior to operation. These are a buffer and an indicator. Be sure the correct, prepared reagents are on hand as different reagents are required to read Free than Total chlorine residual. For reagent preparation refer to section [10.2 Replacing and Installing the Reagents](#).

5.0 Operation

The CLX Online Chlorine Analyzer allows for the measurement of the chlorine of process water on-line. The chlorine value of the process water is usually reported in **milligrams per Liter (mg/L)**, these units are equivalent to **Parts Per Million (PPM)**.

Readings above 10.00 mg/L are outside the range of this instrument. Although the CLX may display above 10.0 mg/L, these readings will not be within the stated accuracy. As the reagents degrade due to aging, readings above 10.0 mg/L may decrease in value.

5.1 Routine Measurement

First, ensure that all plumbing and electrical connections are complete before continuing.

The following steps describe how to measure the value of chlorine of a sample using this instrument:

1. Apply power to the instrument and allow the unit to warm up (typically 45 minutes to one hour on initial commissioning).
2. When a continuous process stream is flowing through the instrument, the instrument will display the measured chlorine level of the sample by displaying it on the LCD screen. In addition, the equivalent signal is provided on the analog (4-20 mA) output, or the digital (RS-485) output, depending on the options selected.

During normal operation, the instrument will have the arrow beside **AUTO** highlighted with the current scale displayed on the lower row of the display and the measured reading on the upper row of the display (see illustration below).

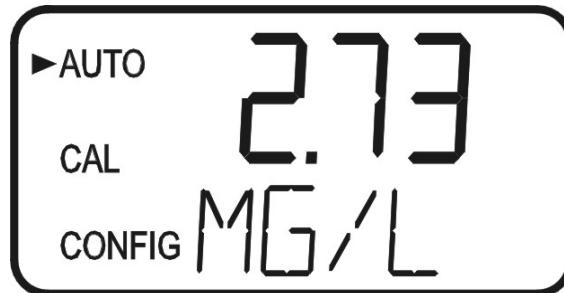

The screen depicted below indicates that the system has just been started or just entered **AUTO** mode from Service mode and no readings have been taken yet.



Please note that calibrations will not be allowed until a reading is posted.



5.2 Security Access Feature

The instrument is equipped with a security access code feature that can be activated in the configuration mode. If the security feature is enabled, the screen shown in the illustration below will appear when the **MODE/EXIT** button is pressed.

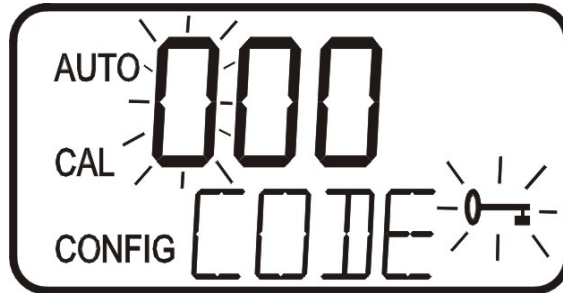

The security code (333) must be entered to gain access to **CAL** or **CONFIG** menus. Notice that the first number in the code is flashing. The flashing indicates that this is the number to be changed. Use the **▲** or **▼** arrows to select the first of the three numbers in the code and then press the **↵** button to accept the first number of the code. Now enter the second number in the code. Proceed as with the first number followed by **↵**. Then repeat the process for the third number in the access code, and finish with the **↵** button.

If the valid access code has been selected, the instrument will be directed to the calibration mode. If the wrong access code is selected, the instrument will return to the **AUTO** mode. Refer to section [7.5 Enabling the Security Access](#) for more information.

5.3 The White LED

A white LED is used to illuminate the measurement cuvette for easy viewing of the instrument operations. During the Zeroing portion of the cycle and the Measurement portion of the cycle, when the green LED is active, the white LED is turned off to lower interference. This normal operation for the instrument and does not represent an error or problem.

The white LED is also used to draw attention to a problem as described in section [9.0 CLX Fault Detection](#). In these instances the white LED blinks at a constant rate dependant on the severity of the problem, but is still turned off as described above. Please note that any fault is always posted to message queue on the lower portion of the LCD.

6.0 Instrument Calibration

The instrument was tested prior to leaving the factory. Since it operates from a pre-determined calibration curve, no calibration is required.

Calibration can easily be performed if required. The method is by comparison against another instrument, such as a laboratory or hand held photometer (such as HF scientific's Chlorine Pocket Photometer).

There are two points of calibration. The slope or gain and the zero (offset). To perform the zero the instrument must be plumbed to a sample of known chlorine free water such as de-ionized water for a zero adjustment.

6.1 Slope (gain) Calibration Procedure

It is important that the chlorine level be quite stable to use this method. The comparison will be made against a trusted measurement such as a chlorine photometer, spectrophotometer, or an amperometric titration.

1. Obtain a grab sample of the flow.
2. Measure the value of the sample with one of the methods shown above.
3. On the CLX, press the **MODE/EXIT** button once. The screen is shown below.

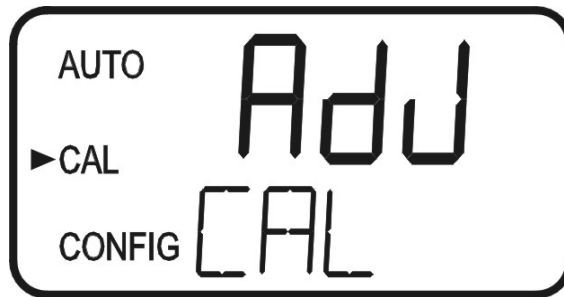

4. Press **↵** to enter the calibration adjustment.



5. The screen will show the current reading on the CLX. Using the **▲** & **▼** buttons adjust the reading to agree with the laboratory method or portable photometer.
6. Press **↵** to accept the calibration adjustment and return to **AUTO** measurement mode.



There is a limit to the size of the change that can be made to a current reading. The upper limit is the current reading times 1.5. The lower limit is the current reading divided by 1.5.

Ensure a reading is posted to the display before calibrating to avoid a nOnE error.

6.2 Zero (offset) Calibration Procedure

Generally this calibration is only required if readings are expected to be below 1 mg/L or if it is required by a regulatory authority. To perform this calibration, the water supply to the CLX must be changed to chlorine free water such as de-ionized water. This chlorine free water must be run through the instrument for at least 5 minutes prior to using the following procedure.

1. On the CLX, press the **MODE/EXIT** button once. The screen is shown below.

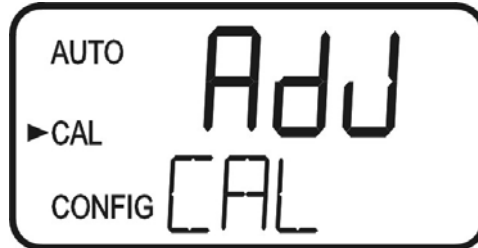

2. Press either the **▲** or **▼** buttons to get the following screen.



3. Press **←** to enter the zero calibration screen.

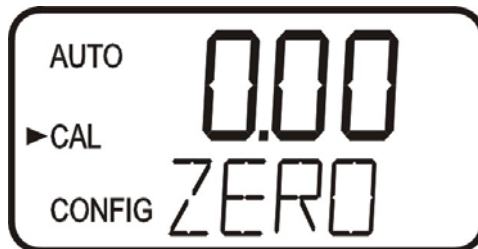

4. The screen will show the current reading on the CLX. Since there is no chlorine, the only reading may be a slight offset due to the absorbance of the reagents. There should be no pink color developed.
5. Press **←** to perform a Zero calibration. When the calibration has completed the instrument will return to **AUTO** measurement mode automatically.



There is a limit of ± 0.20 mg/L total adjustment available. A ZERO Cal. greater than this will cause a CAL warning and no calibration will have occurred. Enter SERVICE mode to clear this error.

6.3 Restore Factory Settings

If the CLX displays a CAL error or the calibration was incorrectly performed, it may be desired to restore the factory calibration. All factory defaults including factory configurations can be reset by holding down the **▲** button and then pressing and releasing the **←** button then releasing the **▲** button.

7.0 Instrument Configuration (CONFIG mode)

The instrument has been designed to provide the ability to customize the instrument according to needs at any time during normal operation. This mode has been split into sub-menus to facilitate instrument configuration. This section describes how to use each of the sub-menus to configure the instrument. While in the configuration mode, the instrument has a time-out feature that automatically returns the system operation to the **AUTO** mode after a fifteen (15) minute period of no button pushes.

Enter the **CONFIG** mode of the instrument by pressing the **MODE/EXIT** button until the arrow beside **CONFIG** is illuminated, then press the \leftarrow button to scroll through the sub-menus.



To exit the **CONFIG** mode, press the **MODE/EXIT** button any changes that were made will be saved.

7.1 Setting the 4-20 mA Output

The first configuration selection is **4-20** for the 4-20 mA output. Select the either **On** or **OFF** using the \blacktriangle and \blacktriangledown buttons. Once the desired output has been set, press the \leftarrow button to accept it. The next prompts will depend on the output selected. Also see sections [7.13](#) & [7.14](#).

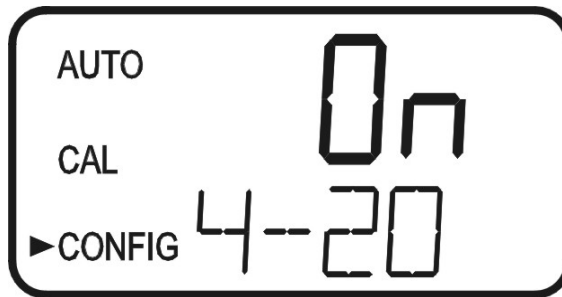

If the 4-20 mA output was turned **On**, prompts to set the 4mA (**4MA**) and 20mA (**20MA**) chlorine limits will be displayed. There will also be a menu to adjust the error level (ERLV). The first prompt will be the chlorine limit assigned to the 4 mA output level:

Select the chlorine level to assign to the **4MA** using the \blacktriangle and \blacktriangledown buttons.

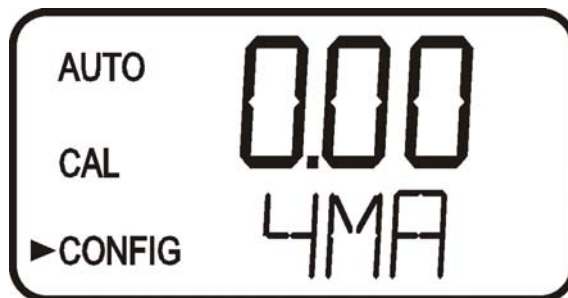

Once the desired level has been set, press the \leftarrow button to accept it.



The **4MA** can be set higher than **20MA** level to invert the output current if required. This may be required to control a dosing pump.

The next prompt will be the chlorine level assigned to the 20MA. Select the chlorine level using the ▲ and ▼ buttons. Once the desired level has been set, press the ← button to accept it.

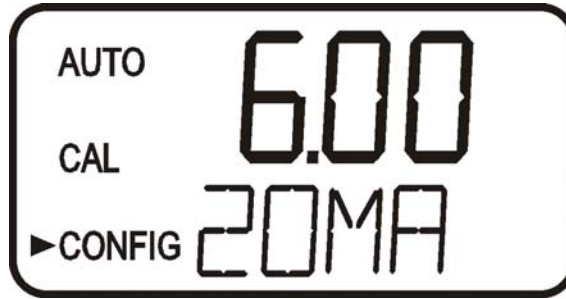

7.2 Configuring the Error Level

In case of an error in the CLX, the 4-20 mA reading can be used to indicate a problem by sending the current to either 4.00 mA, 2.00 mA or 0 mA. The factory default setting is OFF. Select the desired ERLV by using the ▲ and ▼ buttons then press the ← button to accept the desired error response.



7.3 Configuring the RS-485 Port

The instrument is equipped with an RS 485 port which operates in Simple bus, a proprietary communication (for HF Online) or Modbus. Prompts will appear for setting the baud rate, the address and the Modbus transmission mode (RTU or ASCII).

Select the correct baud rate (1200, 2400, 4800, 9600, or 19200) for operation of the I/O port by pressing the ▲ or ▼ buttons to change the displayed baud rate.

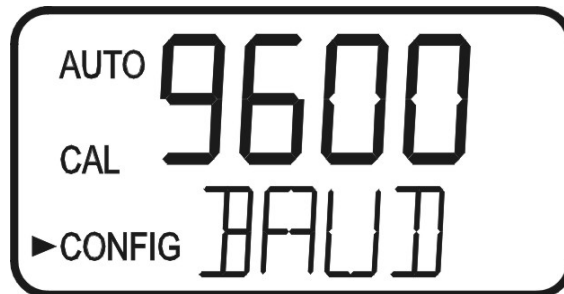

Press the **←** button to continue on and select the desired instrument address using the **▲** or **▼** buttons. Once the selection is satisfactory, press the **←** button.



To use the Modbus mode, select **ASCII** or **RTU**. Refer to the Modbus Manual available from HF scientific or online at www.hfscientific.com.

7.4 Configuring the Alarms

Two relays are provided that are designed to operate as two independent programmable alarms or as a system problem alarm. Please note that changes to alarms will not be recognized until the start of the next cycle. Two settings must be selected to fully program each alarm:

1. The alarm function (HI, LO, OFF or Error)
2. The alarm set point (level at which the alarm activates)

These items are described below:

Alarm Function: The alarms can either be turned OFF or selected to operate in one of three different manners:

1. HI alarm: the relay changes state when the measured chlorine level is higher than the programmed alarm level (set point).
2. LO alarm: the relay changes state when the measured chlorine level is lower than the programmed alarm level (set point).
3. Error alarm: If there is a system fault or problem the alarm will change states.

Alarm Set Point: The level at which an alarm activates is called the alarm set point. On the instrument, the alarm set point is designated as “S/P”. The set point is adjustable to any valid chlorine level over the range of the instrument in steps of 0.01 mg/L. This setting is not available if the Error function is chosen

7.4.1 Alarm 1

Alarm 1 Function: The **ALM1** is displayed and the display indicates the current function of alarm 1 (**HI, LO, OFF, or Error**). Use the **▲** or **▼** buttons to cycle through and select the desired function. Press the **←** button to accept the selection.

If the alarm was turned **OFF**, a prompt will appear to set up alarm 2 (go to section **7.4.2**).

Alarm 1 Set Point: This prompt is used to select the set point for this alarm; this

is indicated by “S/P” shown on the lower row of the display. Select the desired alarm level by using the ▲ and ▼ buttons. Once the desired set point has been set, press the ← button to accept it.

7.4.2 Alarm 2

Repeat the procedure listed in section 7.4.1 to set up the parameters for alarm 2. If a selection was made to turn the alarm **OFF**, the next selection for the speed of response **RESP** is shown.



Due to the cyclic nature of the CLX, relay chatter is not an issue. There is no need for alarm delays or hysteresis.

7.5 Enabling the Security Access

The instrument is equipped with a security access. If this option is turned on, the user is required to input the access code into the instrument to get to any mode other than **AUTO**. The only code is **333**. This code may not be changed. See section 5.2 for more information on this security feature. The security key icon will be visible and flashing on the display whenever the access option is selected using the ▲ or ▼ buttons. (**On** or **OFF**).

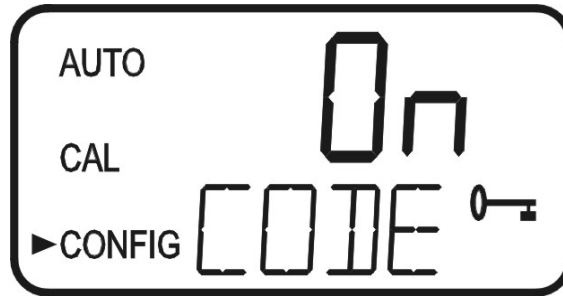

7.6 Extended Settings

The last settings are grouped together to prevent them from being adjusted by accident. To gain access to the extended settings, select **On** using the ▲ or ▼ buttons and press the ← button.

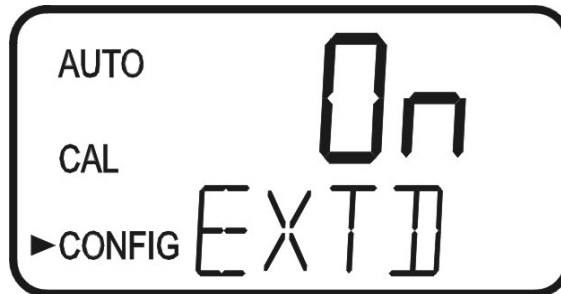

If extended settings are set to **OFF**, pressing the ← button will save all settings and the CLX will automatically return to the normal **AUTO** mode of the instrument.

7.7 Units of Measurement

The unit of measure can be set to either mg/L (milligrams per liter) or PPM (parts per million). The factory setting is mg/L. Select the desired UNIT using the ▲ and ▼ buttons and press the ↵ button to accept it.



mg/L screen

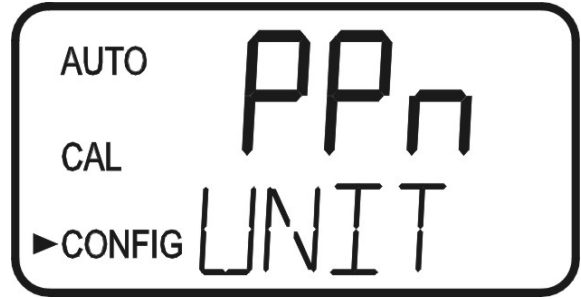

PPM screen

7.8 Averaging and Filtering

The CLX can display and output averaged readings to help smooth out the response and eliminate large reading variation in rapidly changing processes. There are 5 settings for the averaging feature:

- 1 = No averaging, each reading is in “real time”.
- 2 = The current reading and previous reading are averaged.
- 3 = The current reading and previous 2 readings are averaged.
- 4 = The current reading and previous 3 readings are averaged.
- 5 = The current reading and previous 4 readings are averaged.

The factory setting is averaging of 2. Select the desired AVG using the ▲ and ▼ buttons and press the ↵ button to accept it.



In addition to averaging, the CLX has a software filter that limits the change between consecutive readings to 20%. For example, the reading following a reading of 1.00 ppm could not be displayed as higher than 1.20 ppm or lower than 0.80 ppm. This filter also helps smooth out large changes and eliminate reading spikes. After 3 consecutive readings, it is assumed that the large change in the readings is "real", and the filter will be disabled. For example, the change between reading 1 & 2, and readings 2 & 3 will be limited to 20%, but the change between readings 3 & 4 will not be limited.

Note: This software filter is completely disabled when the averaging (AVG) is set to 1.

7.9 LCD Backlight Brightness

The LCD backlight brightness may need to be adjusted. This is of particular interest if multiple instruments are located in the same area and it is desired for the entire group to have the same appearance. Ten levels are available. The factory setting brightness is 8.

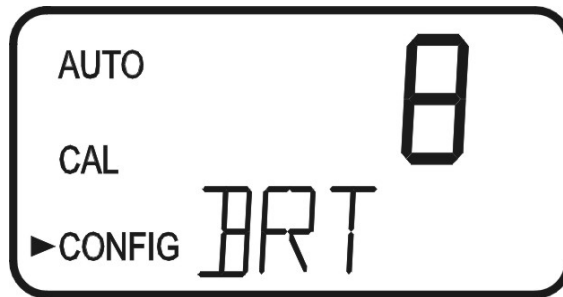

Change the brightness by pressing the ▲ or ▼ button. When the desired brightness has been selected, press the ↵ button.

7.10 RS-485 Parameters

These menus will only appear if the RS-485 is enabled (see 7.3). The factory setting is 8 Bit, no (nOnE) Parity, 1 Stop Bit.

Make selections using the ▲ and ▼ buttons then press the ↵ button to move to the next menu.

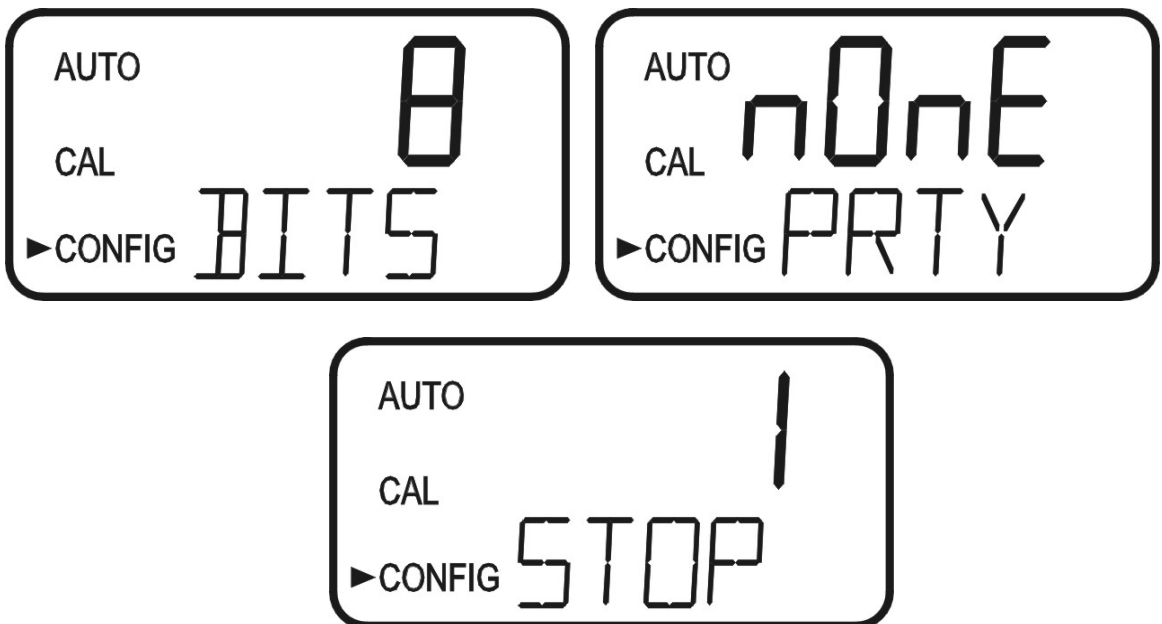

7.11 Cycle Time

The cycle time can be changed using this menu. **Please note that changing this menu will directly affect the volume of reagent that will be consumed.** The default is set to 150 seconds (2 ½ minutes). Using this setting the reagents will last 30 days.

Make selections using the ▲ and ▼ buttons then press the ↵ button. Allowable setting is from 110 to 600 seconds (10 minutes).



Reagents have a 30 day life after being mixed regardless of the cycle time setting.

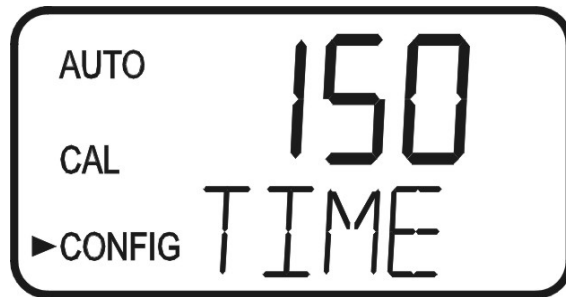

7.12 Water Conservation

To conserve water, the flush time can be adjusted use as little water as possible.

The instrument requires 110 seconds to complete its normal operations, when the **WCON** is turned **On**, at the factory cycle time the instrument sits idle for about 40 seconds. This results in about a 25% water savings. The actual amount of water conservation is dependent on the incoming water pressure and the cycle time setting.

The use of this option may result in some slight loss of accuracy. The factory setting for this option is **OFF**.

Make selections using the ▲ and ▼ buttons then press the ↵ button to exit to **AUTO** mode and save all configuration settings. If the 4-20 mA in section 7.1 is turned ON, there are two additional menus that will appear before returning to **AUTO** mode.



7.13 4mA Adjustment

If the 4-20 mA setting is turned ON ([7.1 Setting the 4-20 mA Output](#)), the following two menus will appear. The first menu outputs a constant 4 mA while allowing for a small amount of adjustment. The adjustment can be made using the ▲ and ▼ buttons. This adjustment will allow the operator to make the CLX agree with a PLC or SCADA system. The adjustment limits are ± 200 counts or about ± 0.2 mA.

This setting will be slightly different on each instrument as each CLX will be factory set to 4.00mA. Press the ↵ button when adjustments are complete to save this setting and move on to the 20mA adjustment.



7.14 20mA Adjustment

This menu operates similar to the previous menu. This menu outputs a constant 20 mA while allowing for a small amount of adjustment. The adjustment can be made using the ▲ and ▼ buttons. The adjustment limits are ± 1000 counts or about ± 1 mA.

This setting will be slightly different on each instrument as each CLX will be factory set to 20.00mA.

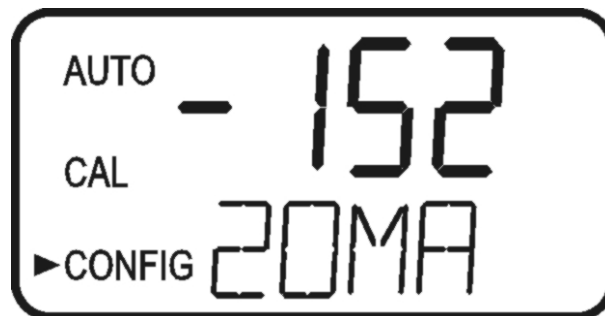

When complete with the 20mA adjustment, press the ↵ button to exit to **AUTO** mode and save all configuration settings.

8.0 Additional Features and Options

8.1 Backlit LCD

The backlit LCD allows for easier readability of the LCD display in low light or no light conditions. The backlight is intended for continuous operation. The brightness is adjustable from a menu in the **CONFIG** mode.

8.2 RS-485 Outputs

The CLX has the capability to operate in three different RS-485 modes. Included is a mode for interfacing into the HF Online software package (section 8.2.1 below), a simple communication mode and Modbus communications. All modes will automatically configure and do not require any changes or selections

8.2.1 HF Online (HF catalog # 19783)

The CLX can operate as a small SCADA system with an optional PC software package, called HF ONLINE. This system allows for an interface with a combination of Micro TOL's or CLX's, totaling up to 255 units, for the purpose of data logging. This system will interface directly with common database and spreadsheet software.

8.2.2 Simple Communication

The CLX can provide basic communications over simple programs such as the Hilgraeve HyperTerminal that is included with most Microsoft Windows packages. The user could also use Visual Basic or other programs. The factory setting communication parameters are 8 bits, no parity and 1 stop bit. These can be changed in the Extended **CONFIG** menus [7.10 RS-485 Parameters](#).

The master computer will send out:

- Byte #1 the attention character “:” in ASCII or 3A Hex
- Byte #2 the address of the CLX being queried
- Byte #3 & 4 CR LF or 0D 0A in hex

The CLX will respond with:

- The same attention character “:” in ASCII or 3A Hex
- The address of the CLX
- The Reading
- The Unit (mg/L)

A sample communication would look like this:

(Master computer requesting a report from address #1) **:1 CRLF**
(CLX set to address #1 Response) **:001 0.0249mg/L**

8.2.3 Modbus Communication

Modbus protocol communication manual is available HF #24569. This manual is available free online at www.hfscientific.com.

8.3 Remote Panel Meter (Catalog # 19609)

The remote panel meter allows for remote indication of the mg/L reading using the 4-20 mA loop of the CLX. No external power is required, as the meter is run off of the 4-20 mA source of the CLX.

8.4 Desiccant Cartridge Option (Catalog #09944)

An optional desiccant cartridge kit can be purchased for use in applications where condensation on the glass cuvette may compromise accuracy. The desiccant changes color from blue to tan when expended. Instructions for replacement are included with the kit.

9.0 Troubleshooting

9.1 CLX Fault Detection

The CLX performs continuous diagnostic monitoring. In the CLX, there are 4 severity levels of fault detection. Level 4, 3 & 2 will allow normal operation, but warn of the problem. Level 1 is an instrument failure and the instrument will not operate. Any faults are displayed in a queue form in the bottom row of the LCD.

A **level 4 fault** is simply a screen indication that one of the alarm levels has been activated. This fault level will not affect the 4-20 mA and will only affect the alarm activated. The sample back light blinks at a rate of once every 4 seconds.

A **level 3 fault** indicates a failure or a problem that usually can be corrected by the operator. Refer to the chart below. If any of these errors occur, the instrument will still display readings and probably will operate correctly. These faults will self-clear when the problem is corrected. If any of these faults occur, they will affect the 4-20mA and any alarm set for fault detection (Error). The sample back light blinks at a rate of once every 2.5 seconds.

Level 3 (Self-Clearing) fault conditions

Message	Description of Fault	Corrective Action
MA	4-20 mA enabled & loop open	Check 4-20 mA wiring or turn off 4-20mA if not used
CAL	Calibration invalid –not accepted	Recalibrate if needed
WATR	No water flowing	Check water flow
FAST	Intake water flow too fast	Set flow rate (see section 9.2)
SLOW	Sample cuvette filling too slowly	Set flow rate (see section 9.2)
PURG	Sample cuvette has slow purge	Check drain lines
NPRG	Sample cuvette not purging	Check drain lines
ISOL	Problem with intake solenoid	Check wiring, check for clogged solenoid
PSOL	Problem with purge solenoid	Check wiring, check for clogged solenoid
RGNT	Problem with reagent	Check reagent and lines
GLAS	Dirty cuvette	Replace or clean cuvette
WCAL	Water Level Calibration Invalid	Clear fault (see section 9.3)
REPL	Reagents Expired	Replace reagents and press PRIME

A **level 2 fault** indicates a severe problem that will usually require technical assistance from HF scientific customer service (see section 9.5). The queued display will show **POST**. If this fault occurs it will affect the 4-20mA and any alarm set for fault detection (Error). The sample back light blinks at rate of once every 1 second.

A **level 1 fault** is a system fault. This is NOT a problem that the operator can correct, and the unit must be returned to the factory for service (see section 9.5). These failures consist of failures in the CPU, A/D, EEPROM or other devices internal to the instrument. The queued display will show **FAIL**, the upper display is a five digit code. If this fault occurs, it will affect the 4-20mA and any alarm set for fault detection (Error). The instrument will not operate with this fault. The sample back light blinks at rate of once every 0.4 seconds.

If any fault condition occurs, the message indicating the fault will be shown on the lower row of the display.

9.2 Setting Flow Rate

The flow rate on the CLX was factory adjusted and should not need adjustment. Installation variances may affect the flow. The optimal flow rate through the CLX may be adjusted if needed. The flow is adjusted by removing regulator vinyl cap and turning the adjustment screw on the pressure regulator. Refer to figure 4. To assist in this adjustment follow the procedure shown below:

1. Press the **SERVICE** button.
2. Wait for the display to read HOLD, then press **Mode/Exit**.
3. Display will show FLOW with the number 0. Press either the ▲ or ▼ button.
4. CLX will drain, and then pulse in water while a count is displayed on the screen.
5. The display will show one of three messages HI, LO or Good.

The flow test determines if the flow rate is suitable for proper operation. Loosen the locking nut then adjust the pressure regulator using a coin or a large flat blade screwdriver. Press either the ▲ or ▼ button while in the FLOW routine to display a new flow rate. Please note that only ¼ turn incremental adjustments should be made to the regulator on each attempt.

If the message is LO, turn the regulator control clockwise. If the message is HI, turn the regulator counterclockwise. If the message is Good, no adjustment is required. Tighten the locking nut after adjustment and replace the regulator vinyl cap. To return to normal operation, press the ↵ button.

9.3 Clearing Faults

Every time **SERVICE** mode is exited, all faults are cleared. If the original fault or a new fault occurs, it will be posted.

9.4 Reagent Clogs

If reagents fail to flow or Prime it may be due to a clog in either the tubing or at a check valve. To alleviate this you may have to flush the system with Chlorine Free water, preferably Deionized water. See section [10.3 Check Valve Flushing Kit](#).

9.5 Diagnostic Chart

Symptom	Cause	Cure
Lower display shows MA	4-20 mA loop open	Check wiring. See sections 4.3.4 and 7.2
Lower display shows FAIL	Major system fault	Refer to section 9.1
Readings are erratic	(1) Bubbles in solution (2) Debris in flow	(1) See above (2) Install T strainer at inlet
Readings are lower than expected	(1) Condensate or leaky measurement cuvette (2) Measurement cuvette dirty (3) Reagents bad or expired (4) Buffer reagent not being dispensed	(1) Install desiccant cartridge kit (2) Replace or clean cuvette (3) Replace reagents (4) Check buffer lines and check valves.
Upper display flashes	Sample Over-Range	Check sample. Sample may be too high to read.
Upper display shows nOnE while attempting to calibrate	No current reading displayed	Wait for CLX to post a reading

9.6 Technical and Customer Assistance

If for any reason assistance is needed regarding this instrument please do not hesitate to contact either the HF scientific Technical Service Department or the HF scientific Customer Service Department:

HF scientific
 3170 Metro Parkway
 Fort Myers, Florida 33916-7597
 Phone: (239) 337-2116
 Fax: (239) 332-7643
 Toll Free: 888-203-7248
 Email: HFInfo@Watts.com
www.hfscientific.com

10.0 Routine Maintenance

10.1 Maintenance Schedule

The recommended schedule is shown below. It is important to replace the reagents on a monthly basis to get reliable accurate readings from the CLX.

The CLX is shipped with one CLX Tubing/Cuvette kit, HF part # 09950. The kit consists of the following:

<u>Qty</u>	<u>Part</u>
2	“A” Cap Assemblies
8	“B” Pump Tubes
1	Cuvette

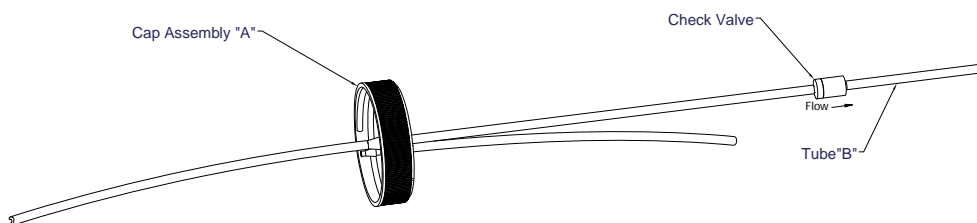

Figure 6: Reagent Tubing Set

The drawing above shows one complete reagent tubing set (check valves not included in kit). Two complete sets are used in the CLX; one for the buffer and one for the indicator.

The supplied kit is intended to last for one year. Additional kits can be ordered from your local HF scientific distributor or representative. It is recommended to keep one kit on hand at all times.

Generally, all “B” tubes should be replaced on a three month basis. The “A” Cap assemblies and the cuvette should be replaced annually.

Every Month

1. The reagent required for operating this instrument must be changed on a monthly basis (with a 2.5 minute cycle time).
2. The external strainer should be checked and cleaned if necessary
3. The glass cuvette should be inspected. Check for excessive debris on the inside surface of the glass. It is suggested to keep a spare cuvette to replace when required. The old cuvette may be cleaned, if possible, for future replacement.

Flushing the System

It is recommended that the tubings replacements be timed with reagent replacement. Press the SERVICE button to stop the water flow. Remove old reagents and discard. Place the inlet tubings in a small container of clean water. Press SERVICE to return to operation mode, press PRIME and then ← to flush the system with water. Remove the inlet tubings from the water Press PRIME and then ← to remove most of the water.



After a PRIME the CLX will perform a water calibration (WCAL). It will take a few minutes to complete this procedure.

3 Month Tubing Replacement

The “B” tubings need replacement more often due to the fact that they are subject to wear from the reagent “Pump”. The check valves should not need to be replaced and should be saved. Please note that the check valves are directional and that the “IN” side is smaller in diameter (see drawing).

Steps:

- 1 Flush the system as described above to reduce personal contact with the reagents.
- 2 Press SERVICE to stop the flow of sample water and drain the cuvette.
- 3 Remove and retain the thumb screw on top of the pump; pull the pump hammer and spring up and out of the way. There is no need to completely remove the hammer and spring.
- 4 Working on one reagent side at a time. Replace the “B” (black) tubing between optics inlet and the check valve OUTLET. Discard the old “B” tubing.
- 5 Ensure the check valve is placed into its seat.
- 6 Repeat steps 4 & 5 for the other reagent.
- 7 Replace the hammer and spring back into place and secure with the thumb screw.
- 8 Check the drawing on the following page to ensure correct installation.
- 9 Return to operation as described.

Annual Tubing Replacement

The “A” Cap Assembly needs to be changed on an annual schedule. Check the condition of cuvette and change if it appears badly soiled or discolored. Follow the steps below:

1. Replace the two “A” Cap Assemblies.
2. Turn the knurled top on the optics system counterclockwise (as viewed for the top) until the cuvette just “pops” out, but do not remove the top.
3. When the cuvette “pops” out, move the retaining o-ring & remove the cuvette. You may need a stiff wire such as a bent paper clip to grasp the cuvette. Retain this cuvette for future use if it can be cleaned.
4. Install the new cuvette by pushing it firmly in place and turning the knurled top clockwise until the cuvette is held securely.
5. Check the drawing on the following page to ensure correct installation.
6. Return to operation as described.

Return to Normal Operation

Press the SERVICE button to return sample flow to the system. Check for leaks. If a leak occurs press SERVICE again, repair leak and try again. Once the system is operating correctly, return or replace reagents and press PRIME and then ↵ one time to restart reagent flow. The system will automatically return to normal operation.



Tubes may darken due to contact with the reagent. This condition does not affect the performance of these parts.

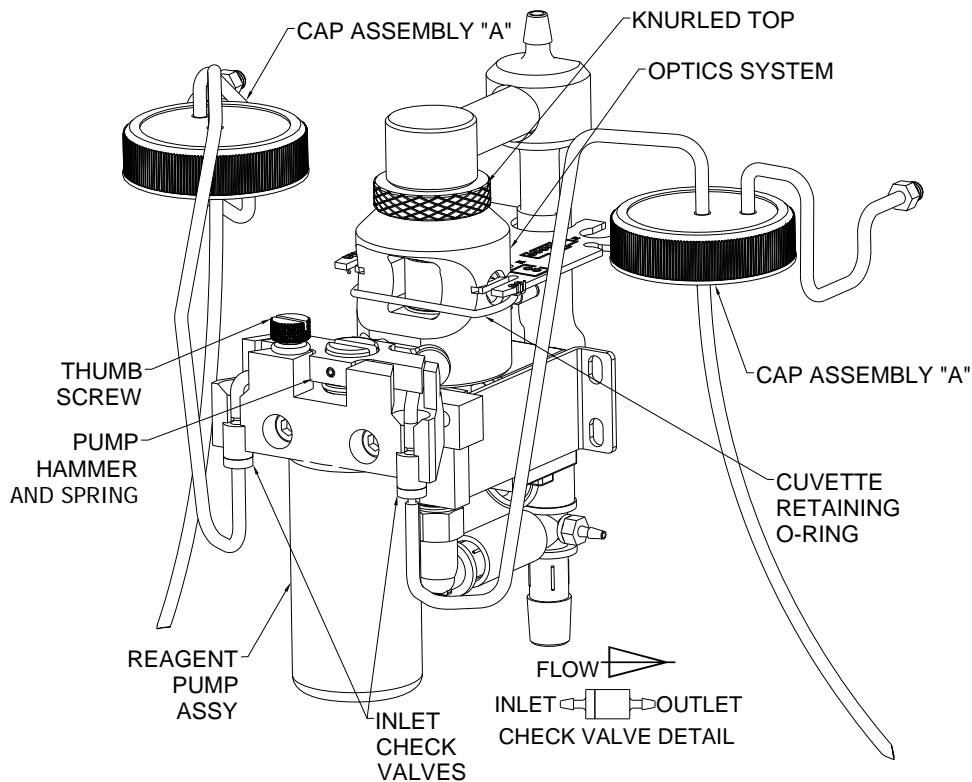

Figure 7: Reagent Tubing Installation

10.2 Replacing or Installing the Reagents

Reagent kits are available from HF scientific for Free Chlorine and for Total Chlorine. Refer to [section 11.0 Replacement Parts and Accessories](#) for the appropriate Catalog numbers. There are two reagents required, and supplied in each kit; the **buffer** and the **indicator**.

The buffer and indicator reagents are provided as dry reagents and require the addition of deionized water. You will need to have at least 1 liter of deionized water on hand prior to preparing the solutions. Allow about ½ hour time to prepare the reagents.



Use caution while preparing. These reagents are caustic and can burn skin and stain clothing. The use of protective gloves, clothing and eye protection is highly recommended.



When commissioning the CLX it is recommended to follow the procedure in section 10.3. This procedure only needs to be done once when first put into service.

Buffer Reagent Preparation

Add about 400 ml of deionized water into the buffer bottle. Cap tightly and shake vigorously until the powder is fully dissolved. When fully dissolved add enough deionized water to bring the volume in the bottle up to the fill line.

Indicator Reagent Preparation

Add about 400 ml of deionized water into the indicator bottle. Cap tightly and shake vigorously until the powder is dissolved. Remove the cap and add the contents of the DPD powder bottle (small brown bottle). Cap and shake to fully dissolve the powder. When fully dissolved add enough deionized water to bring the volume in the bottle up to the fill line.



Once mixed the reagents have an expected life of 30 days. Write the mixing date on the reagent bottle labels in the area provided. Dispose of expired reagents correctly.

To replace the reagents, press the **SERVICE** button; this will empty the cuvette and stop any flow of water. Remove the cap on both bottles replace with the blue cap supplied with the CLX. Be sure to replace the reagents in the correct location as labeled on the inside of the CLX. The buffer is installed on the left and the indicator is installed on the right side. The suction tube for both reagents will reach the bottom of the bottles.

To complete the replacement procedure, press the **PRIME** button and then the ← button. This will draw enough of each reagent to completely prime the tubes and replace any old solution. The system will automatically return to normal operation after it has primed.



Use caution when changing the reagents as they are caustic. These reagents will stain clothing and anything they contact. After changing the reagents, operators should wash their hands.

10.3 Check Valve Flushing Kit

Sometimes upon initial commissioning, the check valves stick and require manual priming. This should not be needed after commissioning. Be careful when using this kit to use only chlorine free water. Complete instructions are included in the kit.

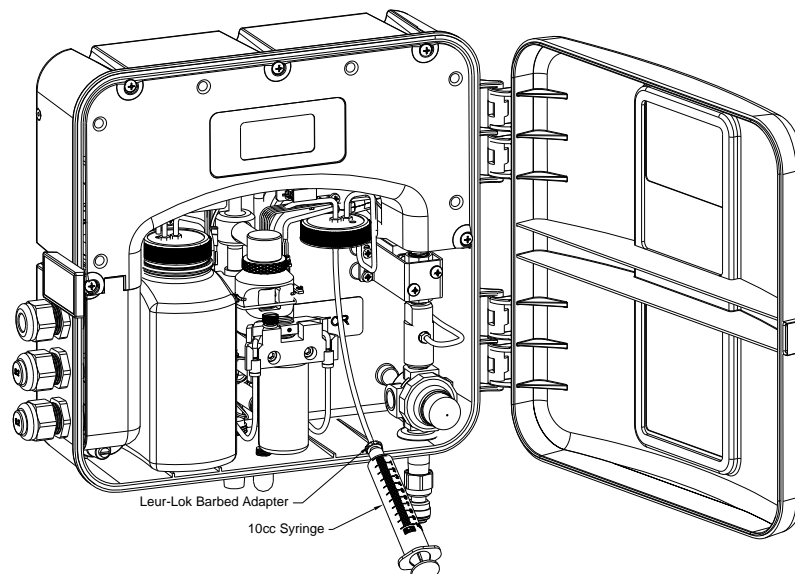

Figure 8: Check Valve Flushing Kit

10.4 Cuvette Change

As recommended in section **10.1 Maintenance Schedule** the cuvette should be inspected at monthly intervals and replaced when needed.



To replace the cuvette, press the SERVICE key. When HOLD shows on the screen, the system is ready.



The cuvette is spring loaded to allow for removal. Leave the cuvette retainer (O-ring) in place while loosening top.

Loosen the knurled top until the cuvette pops out. Pull the cuvette retainer down to allow for cuvette removal. Remove and replace or clean cuvette. Reverse the procedure to replace. To avoid damage do not over tighten the knurled top. Press the SERVICE key to return the system to normal sample flow and check for leaks.

10.5 Instrument Storage

If the CLX is relocated or will be inactive for more than 48 hours, remove the reagents. Flush the reagent system as describe in **10.1 Maintenance Schedule**. Place the instrument in Service mode to drain the system then remove power by disconnecting the mains power plug. It is usually a good idea to disconnect or shut off the source water.

10.6 Cleaning the CLX

Flush the system as mentioned in section **10.1 Maintenance Schedule**. When the flushing is finished, press the SERVICE button wait until the display reads HOLD.

As a mater of safety, always disconnect any power source to the CLX prior to attempting any cleaning. It is recommended that the source water is also shut off.

Isopropyl alcohol (rubbing alcohol) on a soft cotton cloth works very well in removing reagent stains from plastic parts, the key pad and the display. Use care when cleaning around electrical components. Do not use any harsh cleaning agents as these may cause damage to the instrument components.

Ensure that the system is dry prior to applying power.

11.0 Accessories and Replacement Parts List

The items shown below are recommended accessories and replacement parts.

Accessory	Catalog Number
J.A.W. Reagent Kit – Free Chlorine 30 day supply	09951
J.A.W. Reagent Kit – Total Chlorine 30 day supply	09952
J.A.W. Reagent Kit – Free Chlorine 60 day supply	09953
J.A.W. Reagent Kit – Total Chlorine 60 day supply	09954
J.A.W. Reagent Kit – Free Chlorine 12 month supply	09955
J.A.W. Reagent Kit – Total Chlorine 12 month supply	09956
Operating Manual CLX	24420
Tubing/Cuvette Kit	09950
Replacement Cuvette	25018S
Check Valve Set	25017S
Ferrite for 4-20mA or RS-485	24560
Check Valve Flushing Kit	25096

To order any accessory or replacement part, please contact the HF scientific Customer Service Department. If for any reason technical assistance is needed regarding this instrument, please do not hesitate to contact the HF scientific Technical Services Department.

HF scientific
3170 Metro Parkway
Fort Myers, Florida 33916-7597
Phone: (239) 337-2116
Fax: (239) 332-7643
Toll Free: 888-203-7248
Email: HFInfo@Watts.com
www.hfscientific.com

12.0 Warranty

HF scientific, as vendor, warrants to the original purchaser of this instrument that it will be free of defects in material and workmanship, in normal use and service, for a period of one year from date of delivery to the original purchaser. HF scientific's obligation under this warranty is limited to replacing, at its factory, the instrument or any part thereof. Parts, which by their nature are normally required to be replaced periodically, consistent with normal maintenance, specifically reagent, desiccant, sensors, electrodes, tubing and fuses are excluded. Also excluded are accessories and supply type items.

Original purchaser is responsible for return of the instruments, or parts thereof, to HF scientific's factory. This includes all freight charges incurred in shipping to and from HF scientific's factory.

HF scientific is not responsible for damage to the instrument, or parts thereof, resulting from misuse, environmental corrosion, negligence or accident, or defects resulting from repairs, alterations or installation made by any person or company not authorized by HF scientific.

HF scientific assumes no liability for consequential damage of any kind, and the original purchaser, by placement of any order for the instrument, or parts thereof, shall be deemed liable for any and all damages incurred by the use or misuse of the instruments, or parts thereof, by the purchaser, its employees, or others, following receipt thereof.

Carefully inspect this product for shipping damage, if damaged, immediately notify the shipping company and arrange an on-site inspection. HF scientific cannot be responsible for damage in shipment and cannot assist with claims without an on-site inspection of the damage.

This warranty is given expressly and in lieu of all other warranties, expressed or implied. Purchaser agrees that there is no warranty on merchantability and that there are no other warranties, expressed or implied. No agent is authorized to assume for HF scientific, any liability except as set forth above.

HF scientific, inc.
3170 Metro Parkway
Fort Myers, Florida 33916-7597
Phone: (239) 337-2116
Fax: (239) 332-7643
Toll free: 888-203-7248
Email: HFInfo@Watts.com
Website:www.hfscientific.com