



OWNER'S MANUAL

AccUView Wastewater UV Transmission Monitor

HF scientific
3170 Metro Parkway
Ft. Myers, FL 33916
Phone: 239-337-2116
Fax: 239-332-7643
E-Mail: HFinfo@Watts.com
Website: www.hfscientific.com

Catalog No.24743 (1/09)
Rev. 2.9

DECLARATION OF CONFORMITY

Application of Council Directive
Standards to Which Conformity is Declared:

Product Safety - Tested and passed CE EN61010-1: 1990 + A1: 1992 (73/32 EEC)
- Tested and passed ETL (tested to UL 61010B-1)1st Edition, Dated
January 24, 2003
- Tested and passed ETLc (tested to CSA C22.2#1010.1-92)

Immunity – Tested and passed EN61326: 1997+A1: 1998
Including:
IEC61000-4-2
IEC 61000-4-3
IEC 61000-4-4
IEC 61000-4-5
IEC 61000-4-6
IEC 61000-4-8
IEC 61000-4-11

Emissions - Tested and passed EN61326-1: 2006

Manufacturer's Name: HF scientific, inc.

Manufacturer's Address: 3170 Metro Parkway, Fort Myers, Florida 33916-7597

Importer's Name:

Importer's Address:

Type of Equipment: Process Monitor

Model No: AccUView Wastewater

I, the undersigned, hereby declare that the equipment specified above conforms to the
above Directive and Standard

Place: Fort Myers, Florida USA

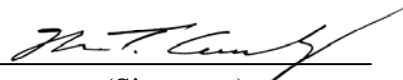
(Signature)

Rowan T. Connelly, General Manager

Table of Contents

Section	Page
Specifications	1
1.0 Overview & Orientation.....	2
1.1 Unpacking and Inspection of the Instrument and Accessories	2
1.2 The Display	3
1.3 The Touch Pad	3
1.4 Vapor Purge.....	4
1.5 The AccUView Wastewater Panel.....	4
2.0 Safety.....	5
2.1 Symbols used on Instrument & In Manual.....	5
3.0 Installation and Commissioning	6
3.1 Mounting and Site Selection	6
3.2 Plumbing	7
3.3 Electrical Connections	8
3.3.1 Power	8
3.3.2 RS-485	9
3.3.3 Relay.....	9
3.3.4 4-20 mA	9
4.0 Operation	10
4.1 Modes of Operation	10
4.2 Warm-up	11
4.3 Routine Measurement	11
4.4 Security Access Feature	11
5.0 Instrument Calibration	13
5.1 100%T Calibration	13
5.2 100%T Calibration Error	14
6.0 Instrument Offset	15
6.1 Restoring Factory Settings	16
7.0 Instrument Configuration (CONFIG mode).....	17
7.1 Selecting the Output (O/P)	17
7.2 Setting the 4-20 mA	17
7.3 Configuring the RS-485 Port	18
7.4 Configuring the Alarm	19
7.5 Offset Calibration.....	19
7.6 Enabling the Security Access.....	20

Table of Contents (continued)

Section	Page
7.7	Extended Settings..... 20
7.8	Speed of Response..... 20
7.9	LCD Backlight Brightness 21
7.10	Ultrasonic Cleaning..... 21
7.11	Pump Period 21
7.12	Pump Time 22
7.13	Settling Time 22
7.14	Measurement Time..... 22
7.15	Desiccant Alarm..... 23
7.16	Saving Configuration Settings 23
8.0	Additional Features and Options 24
8.1	Ultrasonic Cleaning 24
8.2	RS-485 Output..... 24
8.2.1	HF Online 24
8.2.2	Simple Communication..... 25
8.2.3	Modbus Communication 25
8.3	Remote Panel Meter 25
8.4	Heater Option – Model #19571C 25
9.0	Routine Maintenance..... 26
9.1	Cleaning the Flow Through & Cuvette 26
9.2	Replacing or Installing the Desiccant Pouch 26
9.3	Replacing the Source Lamp 27
9.4	Pump 27
9.5	T-Strainer..... 27
9.6	Inlet Strainer 27
9.7	System Tubing Replacement 27
9.8	System Cleaning 28
10.0	Troubleshooting..... 29
10.1	AccUView Wastewater Fault Detection 29
10.2	System Fail Message 29
10.3	Wiring Diagrams 30
10.4	Diagnostic Chart 31
10.5	Technical and Customer Assistance 31
11.0	Accessories and Replacement Parts List 32
12.0	Warranty 33

Specifications

Measurement Range	0 – 100.0 %T
Reproducibility	± 0.1 %T
Resolution	0.1 %T
Accuracy	± 1.0 %T (30%T to 100%T)
Pump Draw	3.6 meters (12 feet)
Flow Rate	0.5 – 1.0 liter/min depending on lift required
Path Length	22 mm(Readings corrected to 10 mm)
Light Source	Low Pressure Mercury Lamp – 254nm
Display	Multi-Line Liquid Crystal Backlit Display
Alarm	Programmable, 120-240VAC 2A Form C Relay
Analog Output	Powered loop isolated 4-20 mA, 600 Ω drive
Communications Port	Optional Bi-directional RS-485 with Modbus
Maximum Water Pressure	1380 kPa (200 psi.) with integral pressure regulator
Operating Temperature	0°C – 50°C (32°F – 122°F) Model 19571C: -10°C – 50°C (14°F – 122°F)
Wetted Materials	Nylon, Quartz, Silicon, Polypropylene, Stainless Steel
Sample Temperature Range	0°C – 50°C (34°F – 122°F)
Power Supply	100– 240 VAC, 47 – 63 Hz, 80VA
Insulation Rating	Double Insulated, Pollution Degree 2, Overvoltage Category II
Environmental Conditions	Not recommended for outdoor use. Altitude up to 2000 meters Up to 95 % RH (non-condensing)
Enclosure Rating	Designed to meet IP 66 /NEMA 4X
Regulatory Compliance And Certifications	CE Approved, ETL listed to UL 61010B-1 & ETL Certified to CSA 22.2 No. 1010-1-92
Shipping Weight	23.6 kg (52 lbs.)
Warranty	1 Year from date of shipment

1.0 Overview & Orientation

The AccUView Wastewater process transmission monitor allows for the UV transmission measurement of process water on-line. The sensor features a low pressure lamp operating at 254 nm. The unit includes a sampling pump capable of drawing water from 3.6m (12 feet) down. The entire unit is enclosed in a weather resistant stainless steel enclosure.

A unique feature of the instrument is the ultrasonic cleaning. Refer to section 8.1 for more information.

1.1 Unpacking and Inspection of the Instrument and Accessories

The table below indicates the items in the monitor shipment.

Item	Quantity
AccUView Wastewater Monitor	1
Instruction Manual	1
Desiccant Pack	1
Quartz Cuvette with Ultrasonic Transducer (Single Pack)	1
Replacement Quick Connect Flow Through Unit	1
100 %T Calibration Standard	1
AccUView Wastewater Installation Kit *	1

* Note – Installation Tubing Kit includes:
15.24 meters (50 feet) tygon tubing
1 foot strainer
Cabinet mounting kit

Remove the instrument from the packing carton. Carefully inspect all items to ensure that no visible damage has occurred during shipment. If the items received do not match the order, please immediately contact the local distributor or the HF scientific Customer Service department.

1.2 The Display

Figure 1 illustrates all the items that can appear on the display. The upper row of the display (1) is used for reporting the %T levels and to provide user guidance in the customer setting routine. The lower row of the display (2) is used to communicate error messages and provide user guidance. All error messages will be added to a queue along with the units (%T). The display has two icons (3) that are used to indicate the use of access code and offset mode. In addition, mode arrows (4) are used to indicate the current instrument operating mode; AUTO (automatic operation), CAL (calibration) and CONFIG (configurations).

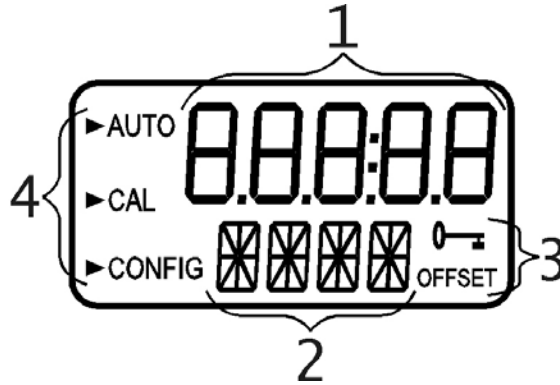

Figure 1 – Display used in the instrument.

All items used on the display are shown in this figure

1.3 The Touch Pad

Figure 2 illustrates the touch pad. The touch pad has four buttons: **MODE/EXIT**, \updownarrow , \blacktriangle , and \blacktriangledown . The **MODE/EXIT** button is used to cycle among the four operational modes of the instrument: **CAL**, **CONFIG**, **SVC** and **AUTO** (Measurement) mode. The \updownarrow button enters the option (or mode that is highlighted or chosen. The \blacktriangle and \blacktriangledown buttons are used to change settings.

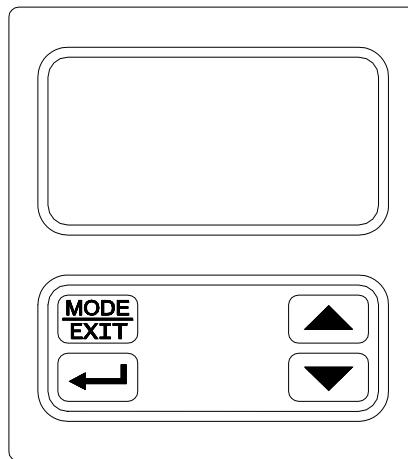

Figure 2: The AccUView Wastewater touch pad.

1.4 Vapor Purge

The AccUView Wastewater sensor is equipped with a continuous vapor purge system. A replaceable desiccant pouch in the lower portion of the instrument dries the air. System heat is used to warm the air. A fan inside the instrument continuously circulates heated dry air around the optical well and the flow through cuvette. This feature eliminates the need for a dry purge line.

The AccUView Wastewater Sensor monitors the replaceable desiccant pouch condition continuously. The LCD display will show **DESC** on the lower line in the event that the desiccant pouch needs replacement. Replacement desiccant pouches are available from HF scientific or the local representative (Part # 21555R). Refer to section **9.2 Replacing or Installing the Desiccant Pouch**.

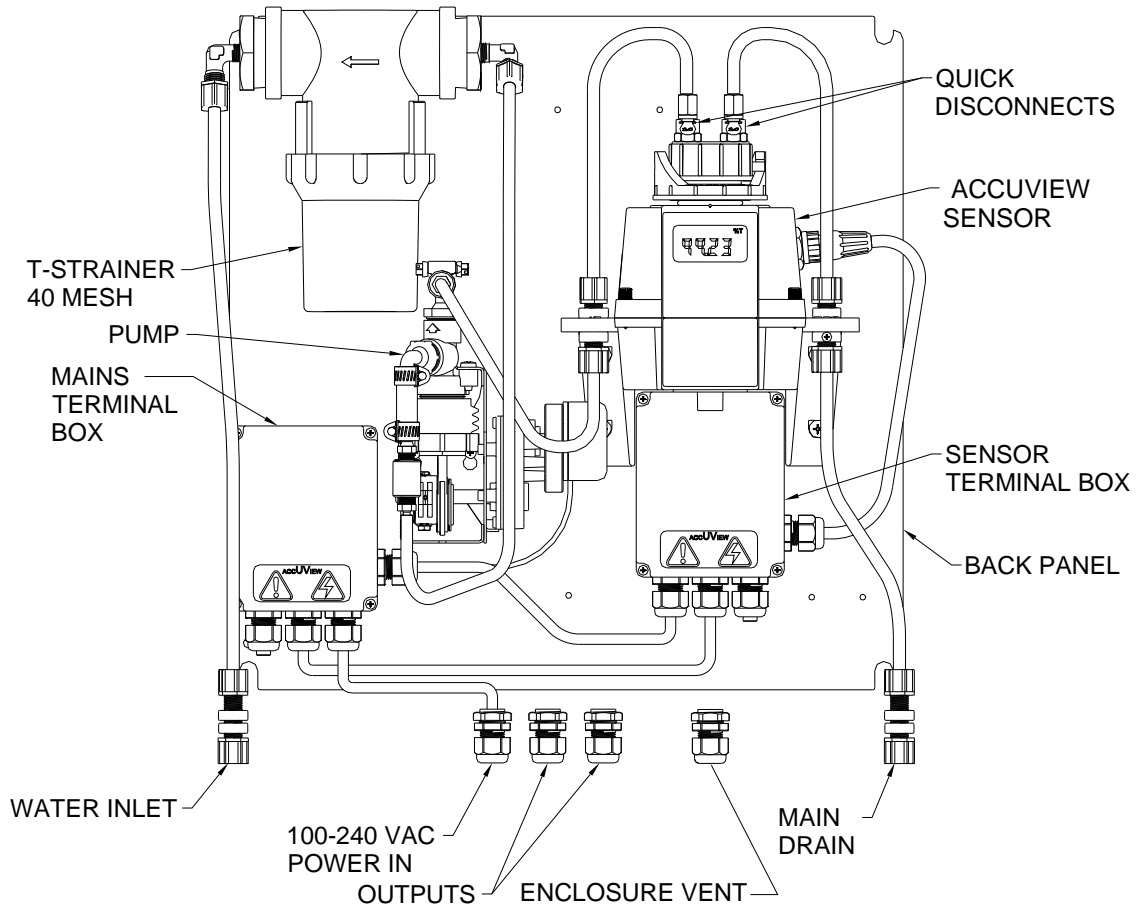

Figure 3: The AccUView Wastewater Panel

1.5 The AccUView Wastewater Panel

All of the main components of the system are mounted on a panel inside the stainless steel enclosure. There is easy access to all serviceable parts. Please note that all terminations are within separate enclosures. This modular approach enables replacement or service of a single module without need to return the entire system. Figure 3 shows all the modules.

2.0 Safety

This manual contains basic instructions that must be followed during the commissioning, operation, care and maintenance of the instrument. The safety protection provided by this equipment may be impaired if it is commissioned and/or used in a manner not described in this manual. Consequently, all responsible personnel must read this manual prior to working with this instrument.

In certain instances **Notes**, or helpful hints, have been highlighted to give further clarification to the instructions. Refer to the *Table of Contents* to easily find specific topics and to learn about unfamiliar terms.

2.1 Symbols used on Instrument & In Manual

Standard IEC symbols are used on the high voltage cover.



ISO 3864, No. B.3.6 Caution, risk of electric shock.

This symbol indicates that hazardous voltages may be present under this cover



ISO 3864, No.B3.1 Caution refer to accompanying documents.

This symbol is reminding you to read the sections in the manual referring to the electrical connections, or other potential hazards.

3.0 Installation and Commissioning

Prior to use for the first time, the supplied desiccant pouch will need to be installed. Refer to section [9.2 Replacing or Installing the Desiccant Pouch](#).

3.1 Mounting & Site Selection

The instrument is designed for wall mounting. For rail mounting, contact HF scientific. Choose a location that is easily accessible for operation and service. Ensure that the front display rests at eye level. Please note that the enclosure has tool access door, allow ample room for this door to fully open. The overall mounting dimensions of the instrument are shown in Figure 4. The recommended mounting screws are M6 (1/4") for the instrument enclosure.

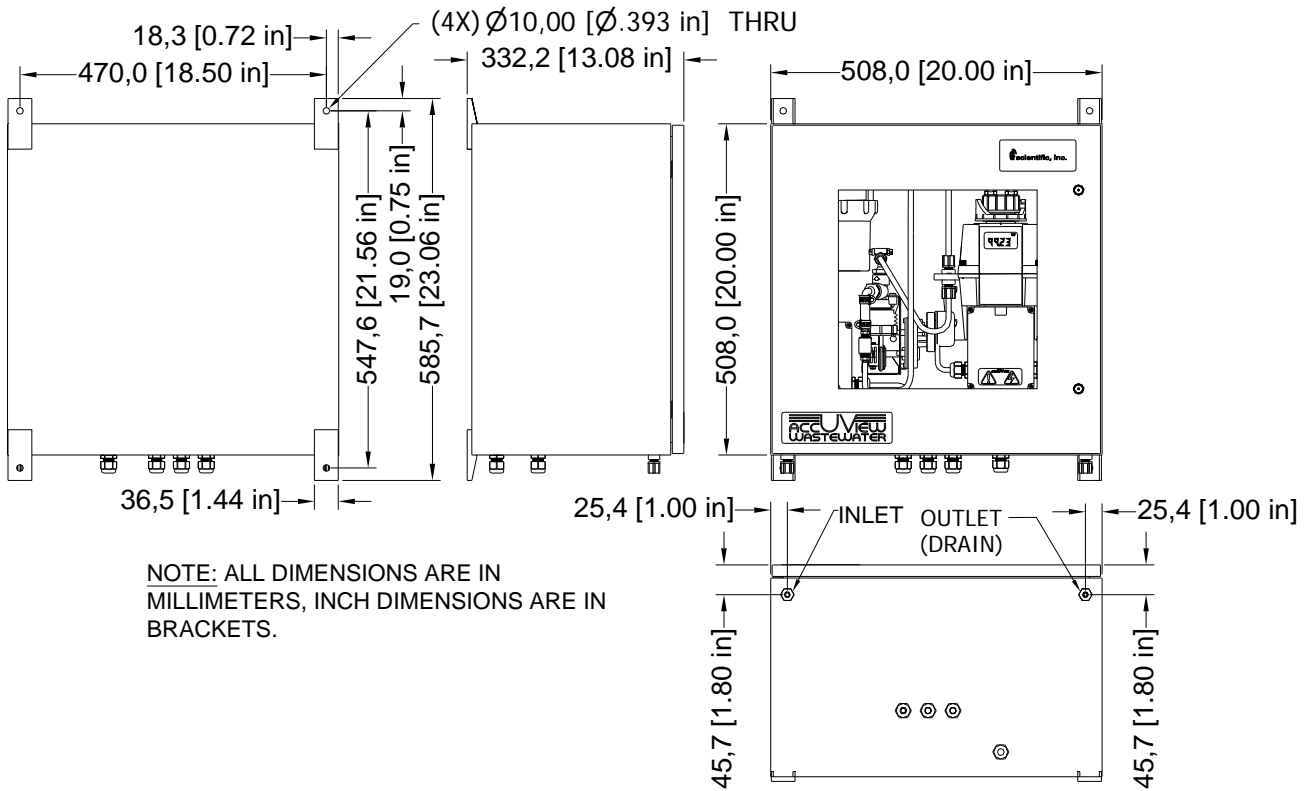

Figure 4: Overall Mounting Dimensions of the Instrument

For faster response the instrument should be mounted as close as possible to the sampling point (within 2-3 meters (6-10 ft) of the sampling point).

3.2 Plumbing

The recommended plumbing for the instrument is shown in Figure 5. The internal bellows pump is capable to drawing water from a depth of 3.6 m (12 ft). To prevent the system from clogging, two strainers are used; a foot strainer at intake line and a T-strainer inside the instrument.

Install the supplied inlet basket strainer onto the inlet line if the flow of the sample water prevents the inlet strainer from remaining submerged, a stand pipe must be used. An example of such a system is shown in figure 5.

Connect the other end of the inlet tubing to the inlet connection on the AccUView Wastewater.



The main drain connection must be open to atmosphere. Please ensure that the drain tubing is connected and run either to a convenient drain. To ensure proper operation ensure there are no loops in the drain line.

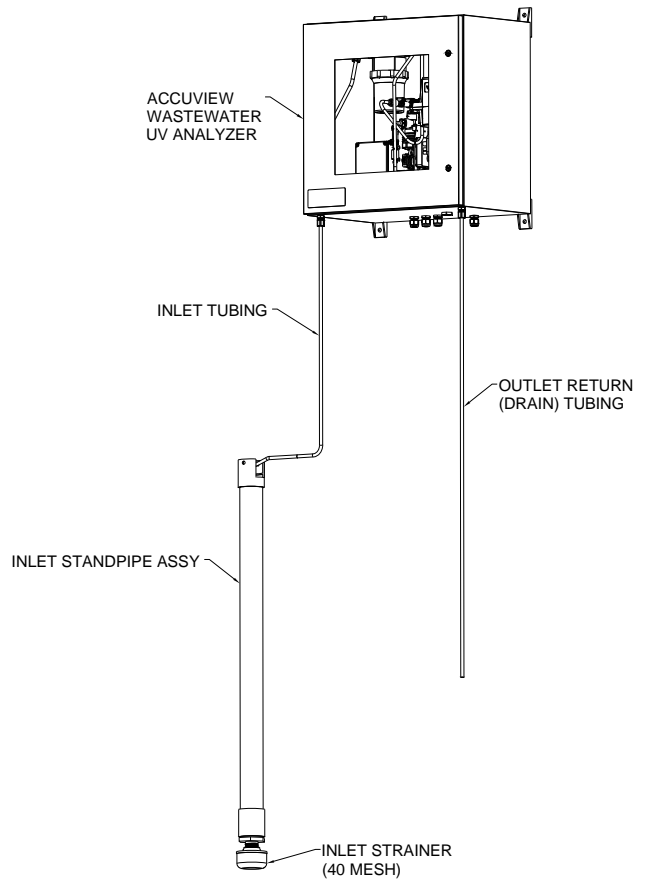

Figure 5: Recommended Plumbing

The sample main drain should NEVER be returned to the stream. This water MUST be sent to a convenient drain.

The instrument is equipped to be plumbed using 4.75 mm (3/16") ID, 8 mm (5/16") OD flexible tubing. Opaque tubing should be used if the tubing will be exposed to sunlight, to prevent algae growth.



Install the desiccant pouch before operating the instrument. Refer to section **9.2 Replacing or Installing the Desiccant Pouch.**

3.3 Electrical Connections

The electrical connections to the instrument are made through the two terminal boxes. The connections are labeled within the terminal boxes and are self-descriptive (see Figures 6 & 7). Please follow all local and government recommendations and methods for installation of electrical connections to and between the instrument and other peripheral devices.

Plugs are inserted into bulkheads when shipped, to ensure a watertight seal. These plugs should be removed and discarded when cabling to these connections.

The power cable bulkhead will accept cable diameters from 5.8mm (.230 in.) up to 10 mm (.395 in.). All terminals are designed to accept wires in the range of 14-28 AWG. All wires should be stripped to a length of 6 mm (¼”). A strain relief strap is provided to reduce tension on the power terminals.

It is the user’s responsibility to assure that the watertight seal is maintained after the terminal box has been wired for operation. If any of the bulkheads are not tightened properly around a cable or plug, the ratings of the instrument will be jeopardized and there is a possibility of creating a shock hazard.



Only qualified electricians should be allowed to perform the installation of the instrument as it involves a line voltage that could endanger life.

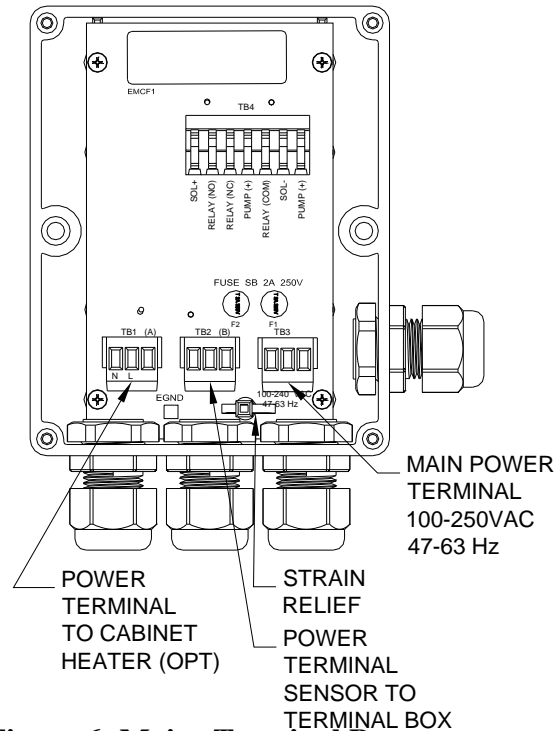

Figure 6: Mains Terminal Box

3.3.1 Power: All mains connections are made in the mains terminal box. The instrument is equipped with a 100-240 VAC, 47-63 Hz switching power supply; please verify that the line voltage falls within these specifications. It is recommended that a circuit breaker be placed prior to the power connection to allow for service. While making connections, refer to Figure 6. The AccUView Wastewater is supplied with a power cord for 120 VAC which is UL and CSA approved.

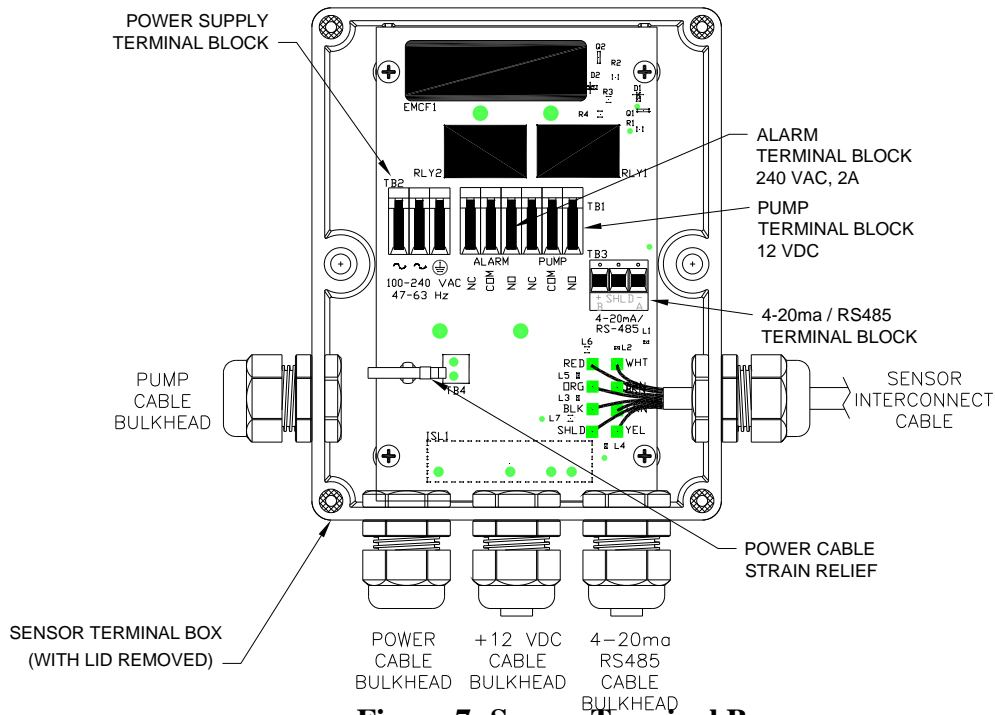

Figure 7: Sensor Terminal Box

3.3.2 RS-485 (optional): The connection for the RS-485 may be made in the sensor terminal box (see figure 7). The RS-485 Modbus or special protocol half-duplex (2-wire) digital interface operates with differential levels that are less susceptible to electrical interferences. This is why cable lengths up to 3000 ft can be implemented. The last device on each bus may require terminating with a 120-ohm resistor to eliminate signal reflection on the line. Do not run RS-485 cables in the same conduit as power.

To prevent damage to the instrument, ensure that power is disconnected prior to making connections. For ease of connecting, remove the plug in terminal block. Connections are labeled beneath this termination.

This factory installed option is available (HF catalog #19851A). Please note that adding this option deletes the standard isolation on the 4-20 mA output.

3.3.3 Relay: Connections for the relay are located in the sensor terminal box (see figure 7). The Alarm relay is a mechanical relay rated at 240 VAC 2A. Please note that the relay is labeled NO (Normally Open), NC (Normally Closed) and C (Common). As this alarm is configured fail-safe, the normal condition is with power applied to the AccUView Wastewater and in a non-alarm condition. Operation of this alarm is covered in section [7.4 Configuring the Alarm](#).

3.3.4 4-20 mA: Connection to the 4-20 mA is made inside the sensor terminal box (see figure 7). The 4-20 mA output is driven by a 15 VDC power source and can drive recorder loads up to 600 ohms. Do not run 4-20 mA cables in the same conduit as power. Operation of this output is covered in section [7.2 Setting the 4-20 mA](#). The outputs are equipped standard with an installed looped powered isolator (500V isolation).

To prevent damage to the instrument, ensure that power is disconnected prior to making connections. For ease of connecting, remove the plug in terminal block. Polarity of the connections is labeled beneath this termination.

4.0 Operation

This process monitor allows for the measurement of the transmission of process water on-line. Process water is usually reported in units of %T. Readings above 102 %T are indicated by a flashing display. Readings above 100 %T indicate that the current sample is better than the calibration water. Readings above 102 %T will cause an alarm condition to occur where the relay will change to the alarm condition and the 4-20 mA will change to 2 mA. Readings above 110 %T are not possible. All readings are mathematically path length corrected to 1cm.

The AccUView Wastewater has an internal pump to draw sample water from a stream. To extend system life and reduce maintenance it operates in a cycle. In the default cycle, the pump runs for five minutes every 30 minutes. After the pump stops, the system waits for the sample to degas then takes a reading. The reading will only be updated once every cycle.

4.1 Modes of Operation

There are four operational modes, **AUTO**, **CAL**, **CONFIG** and **SVC**. All modes can be accessed by sequentially pushing the **MODE/EXIT** key.

Note: Before entering **AUTO** mode, the lower portion of the screen will alternate between **AUTO** and **↵**. This is a pre-Auto condition indicating that the **↵** button must be pushed before normal operation can begin. The pump will start after the **↵** button is pushed as all timers are reset.

During normal operation, the instrument will have the arrow beside **AUTO** (automatic operation) and **AUTO** will be flashing. The scale (%T) is displayed on the lower row of the display and the measured reading on the upper row of the display (see illustration below). The flashing **AUTO** indicates that the ultrasonic cleaning is operating correctly. In this mode the pump will cycle and readings will be taken.

During calibrations the **CAL** (calibration) mode will be used. This mode is indicated by an arrow beside the **CAL**. See section [5.0 Instrument Calibration](#).

The **CONFIG** (configurations) mode is used to change operation of the instrument, or alter the outputs. This mode is indicated by an arrow next to **CONFIG** on the LCD. See section [7.0 Instrument Configuration \(CONFIG mode\)](#).

The last operation mode is **SVC** (service) mode which is used when it is not desired for the pump to operate. This mode can be used to perform various maintenance procedures.



4.2 Warm-up

Upon power-up the AccUView Wastewater will require a warm-up period of about 60 minutes. For improved accuracy allow the AccUView Wastewater to complete warm-up time prior to calibrating. During the warm-up period, the display may flash indicating that it has detected a temperature change. It is normal for this to occur during the warm-up period

4.3 Routine Measurement

Assuming that the instrument has been wired and plumbed as specified in section **3.0 Installation and Commissioning**, the operation is quite simple.

The following steps describe how to measure the %T of a sample using this instrument:

1. Apply power to the instrument and allow the unit an initial warm up of 1 hour.
2. When the pump has run through the first cycle the instrument will display the measured %T level of the sample by displaying it on the LCD screen. As this reading is buffered allow several cycles for best accuracy. After the first hour of operation the instrument should be warmed up and displaying accurate readings. In addition to the display, the equivalent signal is provided on either the analog (4-20 mA) output, or the digital output, depending on the options selected. These signals can be directed to appropriate SCADA, PLC or recording device.

Note: A flashing display may occur after warm-up. This is an indication that either the ambient or the water temperature has changed rapidly. During this time the readings may be slightly out of the specified accuracy. The AccUView Wastewater will automatically compensate as soon as the rate of temperature change slows.

4.4 Security Access Feature

The instrument is equipped with a security access code feature that can be activated in the configuration mode. If the security feature is enabled, the screen shown in the illustration below will appear when the **MODE/EXIT** button is pressed.

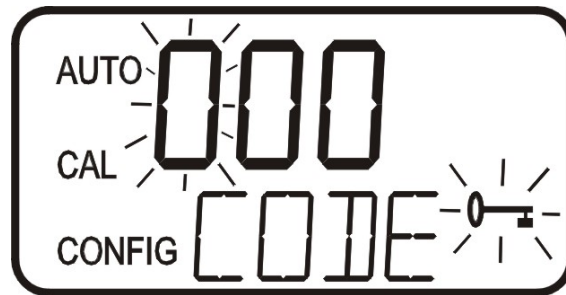

The security code (333) must be entered to gain access to **CAL** or **CONFIG** menus. Notice that the first number in the code is flashing. The flashing indicates that this is the

number to be entered. Use the ▲ or ▼ arrows to select the first of the three numbers in the code and then press the ↵ button to accept the first number of the code. Now enter the second number in the code. Proceed as with the first number followed by ↵. Then repeat the process for the third number in the access code, and finish with the ↵ button.

If the valid access code has been selected, the instrument will be directed to the calibration mode. If the wrong access code is selected, the instrument will return to the **AUTO** mode. Refer to section [7.6 Enabling the Security Access](#) for more information.

5.0 Instrument Calibration

The instrument was calibrated and tested prior to leaving the factory. Therefore, it is possible to use the instrument directly out of the box. Under normal conditions, re-calibration is recommended at least once every month. To get the greatest accuracy calibration may be required once per week.

Two cuvettes and two flow through units are supplied with the instrument so that they can be exchanged with each other. One cuvette and flow through unit should always be kept clean for replacement when calibrating.

Relay contact is held at the last valid condition and will not change state while the instrument is in the calibration and/or in the configuration mode. While in the calibration mode, the instrument has a time-out feature that automatically returns the system operation to the **AUTO** mode after a fifteen (15) minute period of inactivity.

5.1 100%T Calibration

1. Select the calibration function of the instrument by pressing the **MODE/EXIT** button once. The arrow beside **CAL** will be illuminated on the display. The lower display shows alternating **100** (indicating that the 100%T standard is requested) and ↵.

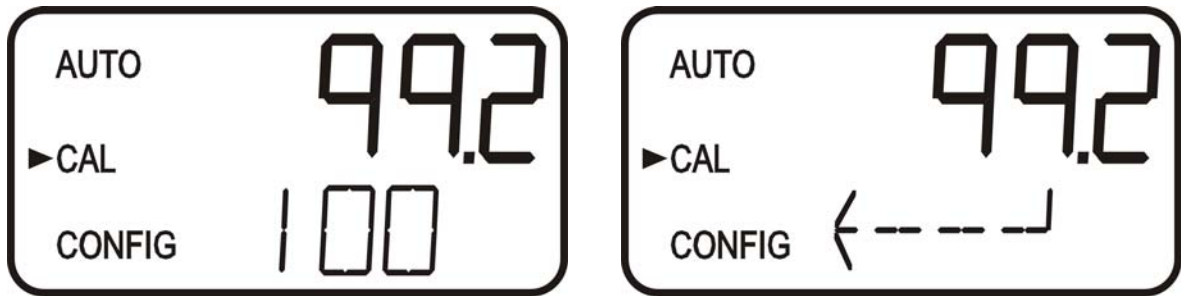

2. Remove the flow through assembly by releasing the quick connect fittings then releasing the flow through clamp. Retain this flow through unit for future cleaning and use.
3. Install the clean, dry flow through unit in which the cuvette is filled with 100%T calibration fluid. Do not connect the quick connect fittings at this time, but lock the flow through down.
4. Press the ↵ button to accept the calibration.
5. The lower display will count down the progress of the calibration step.
6. At the end of the count, the instrument will switch to **pre-AUTO**. The pump will not start in this mode. Connect the quick connect fittings at this time.
7. Press the ↵ button once to enter **AUTO** and resume normal operation.
8. After the instrument has returned to **AUTO**, the pump will run through a cycle.
9. Moving a flow head after calibrating will affect the accuracy of the reading.

Note: It is recommended that the flow through unit be removed for as short an interval as possible to prevent premature saturation of the desiccant.



Warning: Even though the UV lamp is low in power, it is still recommended to avoid looking directly into the optical well while the flow through unit is removed.

5.2 100%T Calibration Error

If the screen shown below is displayed after the 100%T calibration, the internal diagnostics have determined that the calibration fluid requires replacement or the flow through cuvette requires replacement. Check the calibration fluid & cuvette, then recalibrate or restore the factory calibration see [6.1 Restoring Factory Settings](#). The instrument cannot be used without performing one of these operations.

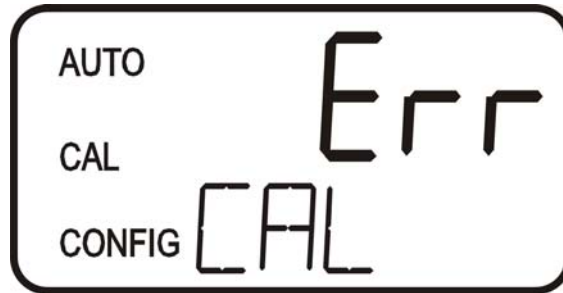

To recalibrate press the MODE key and start the calibration sequence again. To restore the factory calibration, push and hold the \blacktriangle button. Now push and release the \blacktriangledown then release the \blacktriangle button. See section [6.1 Restoring Factory Settings](#)

6.0 Instrument Offset

In certain instances, it may be desirable to use an offset factor to calibrate the instrument rather than performing a physical calibration of the instrument (as described in section 5.1). This procedure is not recommended in lieu of regular instrument calibration but it can be used in situations where the number of instruments used makes regular calibration prohibitive. This calibration technique will make the instrument accurate *only* at levels near the measured value of the grab sample and *not* in the full range of the instrument. Note that the **OFFSET** icon will be illuminated whenever an offset used. The maximum offset is $\pm 1.0 \%T$. If instrument variation is greater than 1 %T a full calibration is recommended.

The procedures are as follows:

1. Collect a grab sample of the process water that is being monitored by the instrument and record the reading reported by the AccUView Wastewater.
2. Take the grab sample and measure its value using a laboratory photometer (contact the HF scientific customer services department for examples of laboratory photometers).
3. Compare the reading reported by the AccUView Wastewater to that obtained in the laboratory. If the readings are very close, then no offset adjustment or calibration is required and the procedure may be stopped at this step. However, if the readings are substantially different (but less than 1 %T) continue on in this procedure to utilize the offset option to improve the reading of the AccUView Wastewater so that it will agree with the laboratory reading between calibrations.
4. Select the offset function of the instrument by pressing the **MODE/EXIT** button until the arrow beside **CONFIG** is illuminated on the display. Refer to the following screen.
5. Push the \downarrow button until **OFST** is displayed on the lower row.
6. At this point, the lower row of the display will indicate the operational status of the offset function (**On** or **OFF**). Change this status by using the \uparrow and \downarrow buttons. Once the desired operational status of the offset function has been set, press the \downarrow button to accept it. If the option was turned off, return to **pre-AUTO** mode by pressing **MODE/EXIT**. Then press the \downarrow button to return to normal operation.

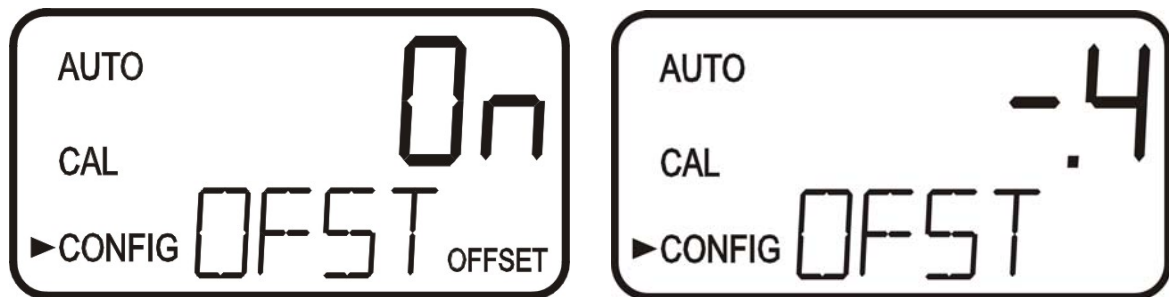

7. If the option was turned **On**, the upper row will display the offset required. This will

add or subtract the value of the offset to the measured %T value. As an example if the AccUView Wastewater measures the process at 92.6 %T but the laboratory instrument read the sample at 92.2 %T, adding an offset of -0.4 would result in the AccUView Wastewater displaying 92.2 % T.

Select the desired offset level using the ▲ and ▼ buttons. Once the desired level has been set, press the ↵ button to accept it.

8. This completes the offset configuration.
9. At this point, the instrument will continue through the configuration (**CONFIG**) mode of the instrument or press **MODE/EXIT** to return to the **pre-AUTO** mode. Then press the ↵ button to return to normal operation.

Note: This offset will remain in effect until it is turned off. It is not cancelled after a calibration.

6.1 Restoring Factory Settings

If the instrument is unable to perform a calibration due to a low lamp output, bad calibration standard or a dirty cuvette, the instrument will display **CAL** on the lower row of the display and **Err** on the upper row. The operator has two choices to correct this problem. If the operator can determine whether a poor calibration or a low lamp caused the problem, he/she can remedy the problem and recalibrate. If all else fails, the operator may restore the factory calibration and configuration settings by performing the following operation. Push and hold the ▲ button. Now push and release the ↵ then release the ▲ button. Factory calibration and factory configuration have now been restored.

Note: Restoring the factory settings allows the use of the AccUView Wastewater with reduced accuracy. The original problem still exists and must be determined and corrected before accurate operation of the AccUView Wastewater will be resumed.

7.0 Instrument Configuration (CONFIG mode)

The instrument has been designed to provide the ability to customize the instrument according to needs at any time during normal operation. This mode has been split into sub-menus to facilitate instrument configuration. This section describes how to use each of the sub-menus to configure the instrument. While in the configuration mode, the instrument has a time-out feature that automatically returns the system operation to the **AUTO** mode after a fifteen (15) minute period.

Enter the **CONFIG** mode of the instrument by pressing the **MODE/EXIT** button until the arrow beside **CONFIG** is illuminated, then press the \downarrow button.

Note: To exit the **CONFIG** mode, press the **MODE/EXIT** button.

7.1 Selecting the Output (O/P)

The first configuration selection is the **O/P**. The selections are **4-20** for the 4-20 mA output, **485** for the RS-485 and **OFF** if no outputs are required. Select the desired output by using the \uparrow and \downarrow buttons. Once the desired output has been set, press the \downarrow button to accept it. The next prompts will depend on the output selected.

7.2 Setting the 4-20 mA

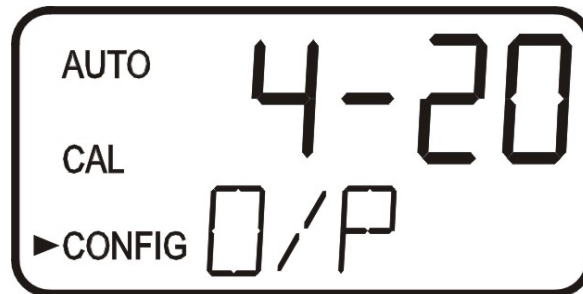

If the 4-20 mA output was turned on, prompts to set the lower (**LOLM**) and upper (**UPLM**) %T limits corresponding to the 4 mA and 20 mA output levels will be displayed. The first prompt will be the limit assigned to the 4 mA output level:

Select the level to assign to the **LOLM** using the \uparrow and \downarrow buttons.

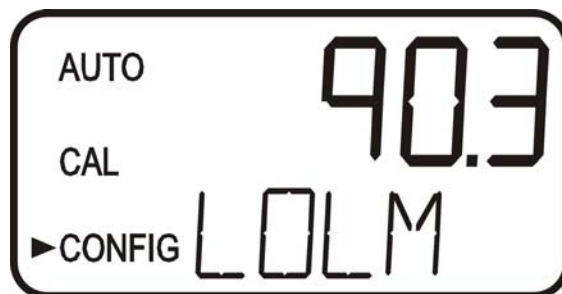

Once the desired level has been set, press the \downarrow button to accept it.

The next, prompt will be the level assigned to the 20 mA output level (**UPLM** on the lower row of the LCD display). Select the %T level to assign to the **UPLM** using the \blacktriangle and \blacktriangledown buttons. Once the desired level has been set, press the \blacktriangledown button to accept it.

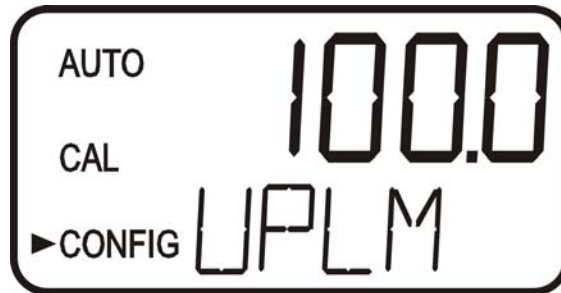

The final prompt for the 4-20 mA setup is for the error level (**ERLV**). This is the current level that the instrument will output when an error occurs for possible errors see section 10.1. The error level selections are 0.00 mA, 2.00 mA, 4.00 mA, or OFF to disable this feature. The default setting is 2.00 mA.

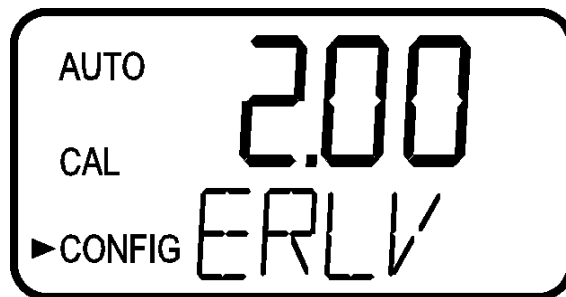

7.3 Configuring the RS-485 Port

If the instrument is equipped with this option (HF cat # 19851A), and the I/O selection is changed to **485**, prompts will appear for setting the baud rate and the address.

Select the correct baud rate (1200, 2400, 4800, 9600, or 19200) for operation of the I/O port by pressing the \blacktriangle or \blacktriangledown buttons to change the displayed baud rate.

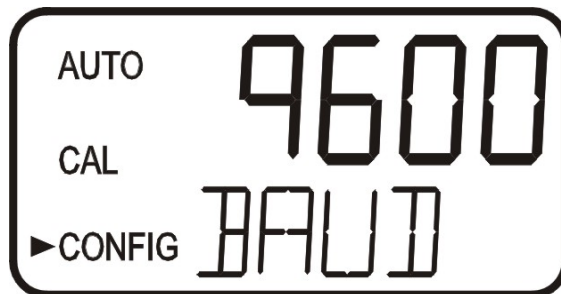

Press the \blacktriangledown button to continue on and select the desired instrument address using the \blacktriangle or \blacktriangledown buttons. Once the selection is made, press the \blacktriangledown button to save the setting.



To enable the Modbus mode, select **ASCII** or **RTU**. For more information refer to the Modbus Manual (Catalog #24570). The manual is also available as a free download from our website at www.hfscientific.com.

7.4 Configuring the Alarm

A relay is provided and is designed to operate as an independent programmable alarm. Two types of information must be input to fully program the alarm:

1. The alarm function (HI, LO, or OFF)
2. The alarm set point (level at which the alarm activates)

These are described below:

Alarm Function: The alarm can either be turned OFF or programmed to operate in one of two different manners:

1. HI alarm: the relay changes state when the measured %T level is higher than the programmed alarm level for a prescribed amount of time.
2. LO alarm: the relay changes state when the measured %T level is lower than the programmed alarm level for a prescribed amount of time.

Note: The relay automatically changes state when an internal system failure is detected.

Alarm Set Point: The level at which an alarm activates is called the alarm set point. On the instrument, the alarm set point is designated as “S/P”. The set point is adjustable to any valid level over the range of the instrument in steps of 0.1%T.

7.5 Offset Calibration

Refer to section **6.0** for more information on this selection.

7.6 Enabling the Security Access

The instrument is equipped with a security access. If this option is turned on, the user is required to input the access code into the instrument to get to any mode other than **AUTO**. The only code is **333**. This code may not be changed. See section 4.4 for more information on this security feature. The security key icon will be visible and flashing on the display whenever the access option is selected using the \blacktriangle or \blacktriangledown buttons. (**On** or **OFF**).

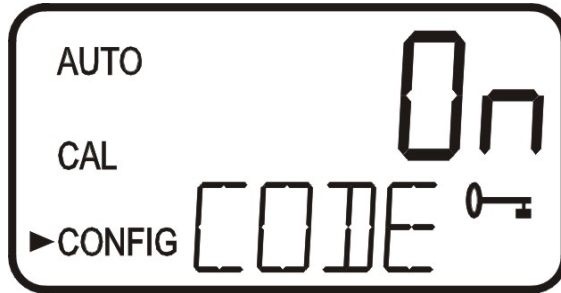

7.7 Extended Settings

The last few settings are grouped together to prevent them from being adjusted by accident. To gain access to the extended settings, select **On** using the \blacktriangle or \blacktriangledown buttons and press the \blacktriangleleft button.

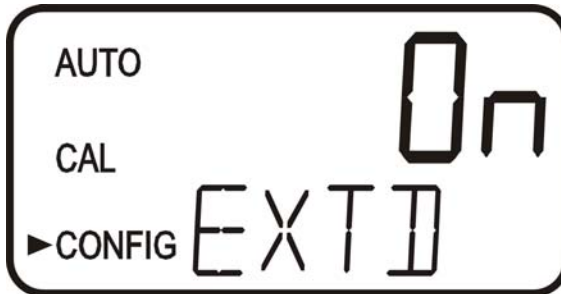

7.8 Speed of Response

The speed of response for both displayed and output values can be adjusted in this menu. The default setting is 10 however, 100 response speeds are available. Select the desired speed of response using the \blacktriangle and \blacktriangledown buttons. Press the \blacktriangleleft button to accept it.

To avoid reading anomalies, select the slowest speed (highest number). Select the fastest response where monitoring of rapid changes is needed.



7.9 LCD Backlight Brightness

The LCD backlight brightness may need to be adjusted. This is of particular interest if multiple instruments are located in the same area and it is desired for the entire group to have the same appearance. Ten levels are available. The default brightness is 8.



Change the brightness by pressing the \blacktriangle or \blacktriangledown button. When the desired brightness has been selected, press the \blacktriangledown button.

7.10 Ultrasonic Cleaning

This allows for a selection menu to turn **OFF** the ultrasonic cleaning function if desired. The default mode is **On**. Make a selection using the \blacktriangle and \blacktriangledown buttons then press the \blacktriangledown button.



7.11 Pump Period

This is the over all time in minutes for cycle. The default is set to 30 minutes, which means the pump will draw a new sample every 30 minutes. The adjustment range is 1 to 60 minutes.

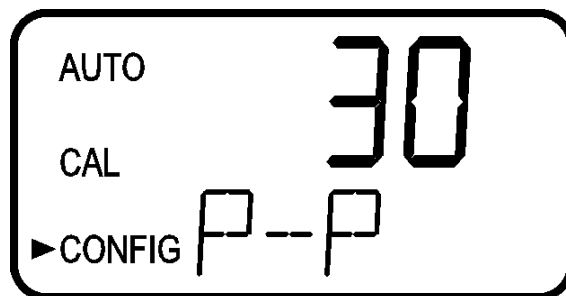

7.12 Pumping Time

This is amount of time in minutes the pump will operate in each pump cycle. The default is set to 5 minutes. If no changes are made to pump settings the pump will run for 5 minutes every 30 minutes

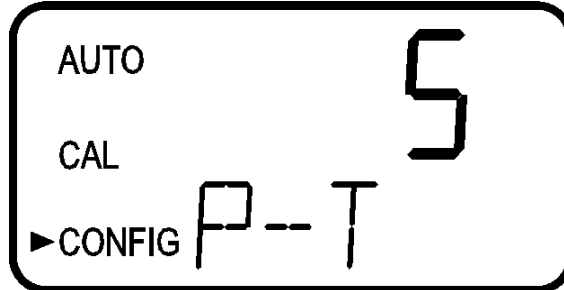

7.13 Settling Time

This is the period of time in seconds where the sample is allowed to settle or degas prior to measuring. The default setting is 20 seconds and adjustment is allowed from 1 to 60 seconds.

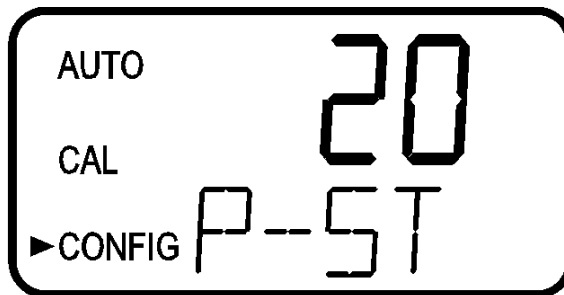

7.14 Measurement Time

This portion of the cycle is where the actual measurements are taken. Measurements are taken during the lamp on time (once every 10 seconds). The default setting of 60 seconds allows for 6 consecutive readings all of which are added to the averaging buffer. Allowable adjustment is from 20-150 seconds.

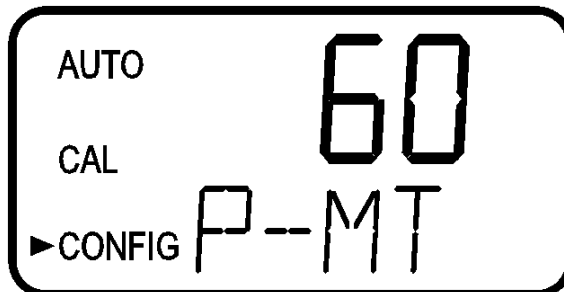

7.15 Desiccant Alarm

When the humidity detector in the AccUView Wastewater indicates that the internal environment is close to the point where humidity could cause condensation, the instrument will display **DESC** as a warning. If desired, a desiccant warning can activate the alarm and send the 4-20mA to 2mA. To activate the alarm when the desiccant fails, select **On** in the **DESC** menu. The default for this menu is **OFF**. Make selections using the **▲** and **▼** buttons then press the **↵** button to move to return to **pre-AUTO** mode. Then press the **↵** button to return to normal operation.

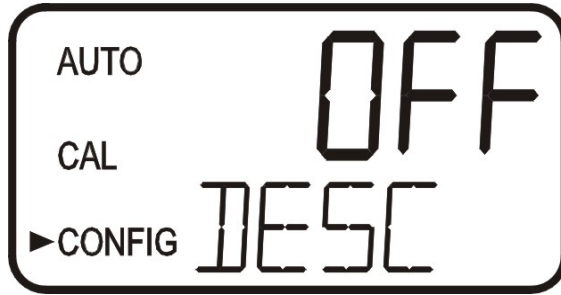

7.16 Saving Configuration Settings

If extended settings is set to **OFF**, pressing the **↵** button will save all settings and the AccUView Wastewater will be sent to **pre-AUTO** mode. Press the **↵** button to return to normal operation.

If extended settings is set to **On**, after the last menu of the extended settings, pressing the **↵** button will save all settings and the AccUView Wastewater will be sent to **pre-AUTO** mode. Press the **↵** button to return to normal operation.

The **CONFIG** menu may be used at any time to reset or change any of the parameters. The **CONFIG** menu may be exited at any point in the menu by using the **MODE/EXIT** key. Any features that have been modified will be saved.

8.0 Additional Features and Options

8.1 Ultrasonic Cleaning

This system is used to continuously clean the flow through cuvette. It is not intended to clean cuvettes that are already dirty, or replace manual cleaning entirely. The system will increase the time between cleanings dramatically. Please note that the system requires the use of a special cuvette. This cuvette must be used for the system to operate correctly.

The system works by sending an ultrasonic frequency through spring connections into a piezo transducer bonded to the bottom of a flow through cuvette.

The system can detect that an incorrect cuvette is installed, an error has occurred in the transducer or the transducer is not making contact with the spring connections. This error is indicated by **CLN** being posted to the lower screen. Since this is an error condition, the alarm will be set and the 4-20 mA will be sent to 2 mA.

If the correct cuvette is installed, and the error is still posted, try rotating the flow through unit slightly to improve the connection. If this fails to work, the cuvette may have to be replaced (Catalog #24232S). The detection for this cuvette only operates in **AUTO** mode. If the system is operating correctly **AUTO** will flash. The cleaning system can be turned off. Refer to section [7.10 Ultrasonic Cleaning](#)

After installing a cuvette, there will be a 30 minute period where the lower screen will post **DRY** to the lower screen. During this time, the ultrasonic circuit will not operate to allow the Vapor Purge system to remove all moisture from the ultrasonic transducer. This is normal and is not considered an alarm condition so no alarm will be implemented. If the cuvette is removed during this period no **CLN** alarm is posted until the 30 minute **DRY** period times out.

Even with the above drying system, it is still recommended that Ultrasonic cuvettes be dried by hand, including the transducer on the bottom prior to use.

8.2 RS-485 Outputs (19851A)

The AccUView Wastewater has the capability to operate in three different RS-485 modes. Included is a mode for interfacing into the HF Online software package (section [8.2.1](#) below), and a simple communication mode. A third operating mode is the Modbus communications. All modes will automatically configure and do not require any changes or selections. Factory installed option cat. # 19851A is required for RS-485 operation.

8.2.1 HF Online (HF catalog # 19783)

The AccUView Wastewater can operate as a small SCADA system with an optional PC software package, called HF ONLINE. This system allows for an interface with up to 255 AccUView Wastewater's for the purpose of data logging. This system will interface directly with common database and spreadsheet software.

8.2.2 Simple Communication

The AccUView Wastewater can provide basic communications over simple programs such as the Hilgraeve HyperTerminal that is included with most Microsoft Windows packages. The user could also use Visual Basic or other programs. The default communication parameters are 8 bits, no parity and 1 stop bit. These parameters may be changed in the extended **CONFIG** menu.

The master computer will send out:

- Byte #1 the attention character “:” in ASCII or **3A** Hex
- Byte #2 the address of the AccUView Wastewater being queried
- Byte #3 & 4 CR LF or 0D 0A in hex

The AccUView Wastewater will respond with:

- The same attention character “:” in ASCII or **3A** Hex
- The address of the AccUView Wastewater
- The Reading
- The Unit (% T)

A sample communication would look like this:

(Master computer requesting a report from address #1) : **1 CRLF**
(AccUView Wastewater set to address #1 Response) :**001 97.4 %T**

8.2.3 Modbus Communication

Modbus communications is fully operational if the RS-485 option (Catalog #19851A) is installed. The Modbus protocol communication information is covered in a separate manual (Catalog #24570). This manual is available as a free download from our website at www.hfscientific.com

8.3 Remote Panel Meter (Catalog # 19609)

The remote panel meter allows for remote indication of the %T reading using the 4-20 mA loop. No external power is required as the meter is run off of the 4-20 mA source.

8.4 Heater Option – Model # 19571C

This factory installed option allows the AccUView Wastewater to be used at lower temperatures where light freezes may occur. This option includes two 30W radiant heater elements controlled by an adjustable thermostat. The use of this option extends the operation of the AccUView Wastewater down to ambient temperatures of -10°C. The thermostat should be set to about 15°C - 20°C to allow the heaters enough time to compensate to dropping temperatures.

To prevent water from freezing in source and drain lines, solenoid valves close during pumping and open to the atmosphere after pumping. This prevents water from being held in the lines and thus prevents the lines from freezing up.

9.0 Routine Maintenance

The hydraulic loop through the AccUView Wastewater is fairly simple. This simplicity keeps cleaning intervals to a minimum.

The chart below shows suggested maintenance periods. As each installation is different, some maintenance periods will vary. It is recommended to always monitor the flow on a daily basis and replace tubing on annual basis.

Maintenance Required	Daily	Weekly	Monthly	Every 3 Months/As Needed	Yearly
Check Flow at Main Drain	X				
Check T-Strainer		X			
Check Cuvette Cleanliness		X			
Check Display for Desiccant Replacement Indication			X		
Clean T-Strainer			X		
Clean Inlet Basket Strainer			X		
Calibrate & Replace Flow Through			X		
Replace Desiccant				X	
Clean Entire System				X	
Replace System Tubing					X

9.1 Cleaning the Flow Through & Cuvette

Measurement cuvettes used for the flow through should be clean and free of marks or scratches. Cleaning is accomplished by cleaning the interior and exterior with a detergent solution and then rinsing several times with distilled or de-ionized water. A 5% solution of phosphoric acid will help remove hard water or calcium deposits. Generally the flow through unit will need to be rinsed. As a safety precaution a mild chlorine solution should be used on both the cuvette and flow head to provide some disinfection. Always rinse the parts completely with distilled or de-ionized water.

9.2 Replacing or Installing the Desiccant Pouch

The AccUView Wastewater continuously checks the condition of the desiccant. When the desiccant gets in such a condition that it may cause problems, the instrument will display **DESC** on the lower portion of the display to indicate the presence of humidity.

Proper use of the supplied desiccant is essential in maintaining the performance of the instrument. The desiccant has been designed to have a long life; however, replacement of the desiccant pouch will be required from time to time.



It is essential that the enclosure seal be maintained to ensure adequate desiccant life. Inspect the enclosure seal each time the desiccant pouch is replaced. Replace any parts found to be defective.

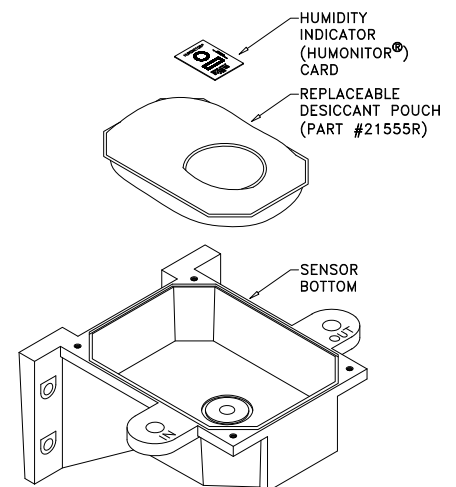

Figure 8: Desiccant Pouch

The desiccant should be replaced when the instrument displays **DESC**. A new sealed desiccant pouch and indicator card are available from HF scientific part #21555R. To initially install or remove the old desiccant, simply unscrew the four corner thumbscrews and remove the electronics half of the instrument. Open the bag protecting the new desiccant pouch and replace (or install) immediately. To speed up the recognition, by the instrument, of the new desiccant it will be necessary to reset the instrument by disconnecting the sensor interconnect cable for 2 seconds and then reconnecting it.



Once the bag is opened, install the desiccant pouch immediately to prevent premature degradation of the desiccant.

9.3 Replacing the Source Lamp

The UV source lamp in the AccUView Wastewater has a rated lamp life of about two years under normal use.

Due to safety concerns it is recommended that the electronic service module be exchanged - Part# 24669S. Whenever the UV source lamp requires replacement an economical exchange program is available. Call the HF Customer Service Department for assistance.

9.4 Pump

The bellows pump is designed for long life. Generally little maintenance is required; however, the check valves will occasionally require removal for cleaning. It is normal for the bellows to discolor. The bellows life is rated for several years of operation. Contact HF scientific if bellows replacement is needed.

9.5 T-Strainer

The T-strainer will require cleaning when full of debris. The cleaning period will be dependent on the pump operation period and the amount of debris in the water. When the level exceeds the visual area, the system should be placed into SERVICE mode (**SVC**) to prevent the pump from cycling. Pull the T-strainer out of the clip and hold over a bucket to catch the water and debris. Rinse the T-strainer bowl and clean or replace the screen. Ensure the bowl seal is replaced. After replacement, dry off any external moisture. Change the operation mode to **AUTO** to resume normal operation. Check for leaks.

9.6 Inlet Strainer

The inlet strainer prevents most of the solids from entering the system. Generally no maintenance will be required as long as flow through the system is evident. If this strainer clogs no sample water can enter the system. This strainer can be cleaned in two ways. The best method is to pull it up and wash it off with fresh water. Where this is not practical, back washing with fresh water can be performed. Do not apply high pressure to the tube as it may rupture.

9.7 System Tubing Replacement

Although the internal system tubing should last a long time, an annual system tubing replacement will ensure a reliable system. Inspect the condition of the tubing for any evidence of deterioration. A replacement system tubing kit part # 24700S is available.

9.8 System Cleaning

The suggested cleaning period is once every three months. As this is very site specific, this period will have to be adjusted as required.

Cleaning is recommended with chlorine to remove algae and then a Lime-A-Way to remove calcium and lime. The system should be flushed after cleaning with each solution.

Steps:

1. Press the **MODE/EXIT** key to change the instrument to the **SVC** mode. This will ensure the pump will not start.
2. Disconnect the main drain and inlet tubings.
3. Install shorter tubings to perform the cleaning locally. These should be just long enough to reach a bucket placed under or near the system.
4. Clean the T-Strainer. As described in section 9.5 above.
5. Drop both the source line and the drain line into a bucket containing 6% Sodium Hypo chloride (bleach) solution.
6. Initiate a pump cycle by pressing the **MODE/EXIT** key to switch to the **pre-AUTO** mode, and then press ↵ to return to **AUTO** and run the pump. Allow the pump to run through its full pumping cycle.
7. Press the **MODE/EXIT** key to change the instrument to the **SVC** mode. then transfer the source line into a container at least 8 liters (2 gallons) of clean water. Route the drain either to another container or to a convenient drain.
8. Initiate a pump cycle by pressing the **MODE/EXIT** key to switch to the **pre-AUTO** mode, and then press ↵ to return to **AUTO** and run the pump. Allow the pump to operate until the container is empty.
9. Press the **MODE/EXIT** key to change the instrument to the **SVC** mode.
10. Drop both the source line and the drain line into a bucket containing a solution of 50% Lime-A-Way and 50% water.
11. Initiate a pump cycle by pressing the **MODE/EXIT** key to switch to the **pre-AUTO** mode, and then press ↵ to return to **AUTO** and run the pump Allow the pump to operate through its full pumping cycle.
12. Flush by repeating steps 7-9 above.
13. Reconnect the normal inlet and main drain lines.
14. Switch to **AUTO** mode to continue normal operation.

10.0 Troubleshooting

10.1 AccUView Wastewater Fault Detection

The AccUView Wastewater performs continuous diagnostic monitoring. In the AccUView Wastewater there are three levels of fault detection; warnings, errors and failures. Any faults are displayed in a queue form in the bottom row of the LCD.

A **warning** is simply a screen indication of a problem. No alarm is activated. If the desiccant alarm is turned off and the desiccant becomes saturated, a screen warning of **DESC** will appear.

An **error** indicates a fault or a problem that usually can be corrected by the operator. These errors consist of lamp low output (**LAMP**), 4-20 mA loop open (**MA**), bad 100%T calibration (**CAL Err**), if desiccant alarm activated and replacement required (**DESC**). An additional message will indicate that the ultrasonic transducer is not making contact or the flow through has been removed (**CLN**). If any of these conditions occurs, the alarm relay will be activated and the 4-20 mA output will be sent to the ERLV setting. See section 7.2. If any of these errors occur the instrument will still display readings, however the accuracy is not known and the instruments readings should not be trusted.

A **failure** is a system fault. This is NOT a problem that the operator can correct, and the unit must be returned to the factory for service. These failures consist of failures in the CPU, A/D, EEPROM or other devices internal to the instrument (**FAIL**). If a failure occurs, the instrument will not function properly and will display the word FAIL on the lower row, the alarm relay will be activated and the 4-20 mA output will be sent to the ERLV setting. See section 7.2 .

If any fault conditions occur, the message indicating the fault will be shown on the lower row of the display.

At power-up for 30 minutes and at operating temperatures outside of our specifications, the %T reading may flash. When this happens the reading may be outside of the stated tolerance

10.2 System FAIL Message

Normally, this condition indicates that the instrument will require servicing. Contact either the HF scientific Technical Service Department or the HF scientific Customer Service Department.

HF scientific
3170 Metro Parkway
Fort Myers, Florida 33916-7597
Phone: (239) 337-2116
Fax: (239) 332-7643
Email: HFinfo@Watts.com
www.hfscientific.com

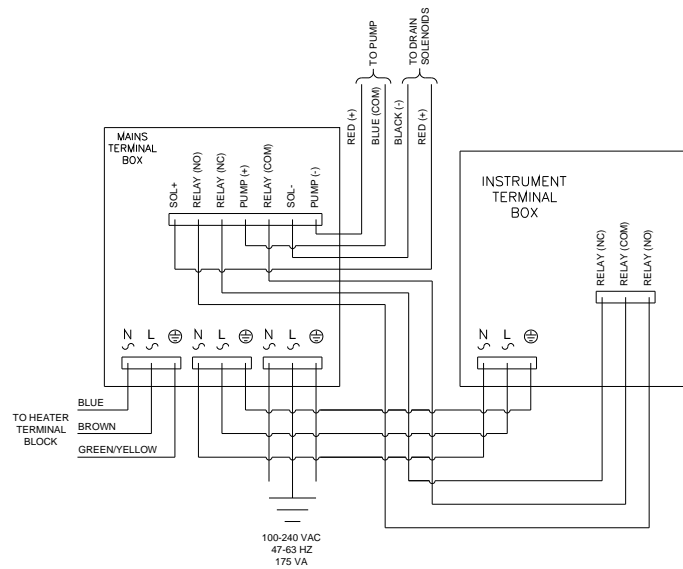

Figure 11: Power Box Wiring

10.4 Diagnostic Chart

Symptom	Cause	Cure
Lower display shows MA	4-20 mA loop open	Check wiring. See sections 3.3.4 and 7.2
Lower display shows DESC	Desiccant pouch bad	Change desiccant pouch. See section 9.2
Lower display shows LAMP	Lamp failed	Replace lamp. Refer to section 9.3
Lower display shows CLN	Ultrasonic cleaning failure	Refer to section 8.1
Lower display shows CAL Err after a calibration.	100%T Calibration failure	Refer to section 5.2
Lower display shows FAIL	Major system fault	Refer to section 10.1 & 10.2
Readings are lower than expected	<ol style="list-style-type: none"> (1) Bubbles in solution (2) Condensate or leaky cuvette (3) Flow through cuvette dirty Instrument out of calibration	Increase P-ST. Refer to section 7.13 Check flow through cuvette for condensate or leaks. Clean cuvette. See section 9.1 Recalibrate. Refer to section 5
Readings are erratic	<ol style="list-style-type: none"> (1) Bubbles in solution (2) Debris in flow through 	<ol style="list-style-type: none"> (1) See above (2) Clean debris from cuvette
Readings are higher than expected	Instrument out of calibration	Recalibrate. Refer to section 5

10.5 Technical and Customer Assistance

If for any reason assistance is needed regarding this instrument please do not hesitate to contact either the HF scientific Technical Service Department or the HF scientific Customer Service Department. Contact information is shown on section [10.2](#).

11.0 Accessories and Replacement Parts List

The items shown below are recommended accessories and replacement parts.

Accessory	Catalog Number
Replacement Desiccant Pouch	21555R
100 % T Calibration Solution - 500 ml	19323
UV Lamp Replacement Module	24767S
Quartz Replacement Cuvette with Ultrasonic Transducer	24232S
Flow Through Assembly with quick release(cuvette not included)	24745S
Flow Head O-Ring Kit (5 Flow Head Seals + 1 Flow Head O-Ring)	50136
Operating Manual, AccUView Wastewater	24743
HF Online Software for data collection and reporting	19783
Replacement Tubing Kit	24700S
T-Strainer Gasket 3-pack	24812
T-Strainer 40 Mesh Replacement Screen	22299

To order any accessory or replacement part, please contact the HF scientific Customer Service Department. If for any reason technical assistance is needed regarding this instrument please do not hesitate to contact the HF Technical Services Department.

HF scientific
3170 Metro Parkway
Fort Myers, Florida 33916-7597
Phone: (239) 337-2116
Fax: (239) 332-7643
Email: HFinfo@Watts.com
www.hfscientific.com

12.0 Warranty

HF scientific, as vendor, warrants to the original purchaser of this instrument that it will be free of defects in material and workmanship, in normal use and service, for a period of one year from date of delivery to the original purchaser. HF scientific's obligation under this warranty is limited to replacing, at its factory, the instrument or any part thereof. Parts, which by their nature are normally required to be replaced periodically, consistent with normal maintenance, specifically reagent, desiccant, sensors, electrodes and fuses are excluded. Also excluded are accessories and supply type items.

Original purchaser is responsible for return of the instruments, or parts thereof, to HF scientific's factory. This includes all freight charges incurred in shipping to and from HF scientific's factory.

HF scientific is not responsible for damage to the instrument, or parts thereof, resulting from misuse, environmental corrosion, negligence or accident, or defects resulting from repairs, alterations or installation made by any person or company not authorized by HF scientific.

HF scientific assumes no liability for consequential damage of any kind, and the original purchaser, by placement of any order for the instrument, or parts thereof, shall be deemed liable for any and all damages incurred by the use or misuse of the instruments, or parts thereof, by the purchaser, its employees, or others, following receipt thereof.

Carefully inspect this product for shipping damage, if damaged, immediately notify the shipping company and arrange an on-site inspection. HF scientific cannot be responsible for damage in shipment and cannot assist with claims without an on-site inspection of the damage.

This warranty is given expressly and in lieu of all other warranties, expressed or implied. Purchaser agrees that there is no warranty on merchantability and that there are no other warranties, expressed or implied. No agent is authorized to assume for HF scientific, any liability except as set forth above.

HF scientific, inc.
3170 Metro Parkway
Fort Myers, Florida 33916-7597
Phone: (239) 337-2116
Fax: (239) 332-7643
Email: HFinfo@Watts.com
Website: www.hfscientific.com