



SunTouch[®]
WarmWire[®]



INSTALLATION MANUAL

888-432-8932 www.suntouch.com

Please be aware that local codes may require this product and/or the control to be installed or connected by an electrician.



Welcome to SunTouch WarmWire

WarmWire is a simple, economical way to warm any floor, and provide years of lasting comfort. This instruction manual provides complete details, suggestions, and safety precautions for installing this floor-warming system.

Fasten the cables to the floor. Then, depending on the floor coverings to be used, put down a layer of thin-set, thick-set, or self-leveling mortar on top of the cables. Finally, install the floor coverings. It's that simple!

Table of Contents

Phase 1: Design the System 3
 Specifications 4
Phase 2: Preparation..... 4
 Cautions 4
 Tips 5
 Items Needed 5
Phase 3: Inspect the Cable and Sensor 5
 Cable and Sensor Resistance Log..... 6
Phase 4: Electrical Rough-in..... 7
 New Construction 7
 Existing Construction 7
Phase 5: Install the Cable..... 8
 Getting Started..... 8
 General Installation 9
 Other Installations 10
 Final Steps..... 11
Phase 6: Finish Wiring 12
 New Construction 12
 Existing Construction 12
Phase 7: Install the Control..... 13
Phase 8: Install the Floor Coverings 13
Phase 9: Install Insulation 13
Phase 10: System Operation 13
Troubleshooting Guide..... 14
Appendix 1: Types of Construction 15
Appendix 2: Typical Electrical Wiring Diagrams ... 17
Appendix 3: Connecting Multiple Cables 19
Appendix 4: Connecting the LoudMouth™ 20
Appendix 5: Sample Layouts..... 21

Installation Facts

Time to install

An average size bathroom should take about two hours to install the cables and about four hours to install the electrical box, control, and power supply.

Skill level

Intermediate skills in electrical wiring and laying floor coverings required. Consider hiring an electrician to rough in the wiring, especially if it is necessary to route from the circuit breaker panel. **Please be aware that local codes may require this product and/or the thermostatic control be installed or connected by an electrician.**

Expected floor temperature

The floor temperature attainable is dependent on how well the floor is insulated, the temperature of the floor before start up, and in the case of uninsulated slab applications, the thermal drain of the underlying materials. These are the three most common installations:

1. Wood framing: With the cable installed on a well-insulated wood subfloor, and thin-set mortar and tile on top, most floors can be heated up to 20°F warmer than they would otherwise be.

2. Insulated concrete slab: With the cables installed on an insulated concrete slab, and thin-set mortar and tile on top, most floors can be heated up to perhaps 15°F warmer than they would otherwise be.

3. Uninsulated concrete slab: With the cables installed on an uninsulated concrete slab, and thin-set mortar and tile on top, most floors can be heated up to perhaps 10°–15°F warmer than they would otherwise be.

Please consult a designer or the factory if questions remain about the surface temperature that can be expected from the cables in any particular construction. Please see “Phase 9: Install Insulation” on page 13.



STEP 1.1

Phase 1: Design the System

WarmWire should be installed in all interior floor areas that are to be warmed. It cannot be used for exterior applications, snow melting, or in ceilings. In some applications, it can be used to heat the room as well, but in general it is not designed for this purpose (heat-loss calculations must be made to determine if enough heat will be provided to match the heat loss of the room).

STEP 1.1 Make a sketch of the room. Measure the total square footage of floor area to be warmed (measurements should be made all the way to the edge of walls, cabinets, tub, etc., for now). Keep in mind the following:

- Heat will not radiate beyond about 2" on either side of the cable, therefore consistent coverage is important.
- The cables can be installed in permanent bench seats with tile or stone coverings.
- Only cables with model numbers ending "-J" on the UL tag may be installed into shower floors and bench seats. However, do not install them into the walls. Acceptance of this shower application must be verified by the local inspector or authority having jurisdiction. See Step 5.22 and Appendix 5 for details and precautions.
- Do not install the cables underneath cabinets or fixtures or inside a wall. Excessive heat will build up and cause damage.
- Do not run the cables into small closets or other confined areas where excessive heat will build up.
- Do not install cable within about 1-1/2" to 2" from a counter or vanity in the kick-space to ensure warmth in this area.
- Do not install the cables closer than 6" from toilet rings to avoid possible melting of wax rings.
- In open areas, like sunrooms or dining rooms, consider installing the cables 6" to 12" away from the perimeter of the room since people rarely stand this close to walls.



NEVER use less than 2" spacing.

STEP 1.2 Select the cable spacing. Below are typical spacings for various types of rooms. This spacing can vary depending on the insulation of the floor and room, and the desired effect. Never space cables closer than 2" apart; this will cause a very hot area and may cause damage.

Typical uses:

- **2" spacing:** Sunroom floors, basement slabs, and baths with exterior walls. (NOTE: Insulation is always recommended due to high heat losses in these areas. Performance is never guaranteed due to construction and climate differences in these applications.)
- **2-1/2" spacing:** Bathrooms, kitchens, living areas, and basements.
- **3" spacing:** Hallways, entryways, and large areas with low heat loss.

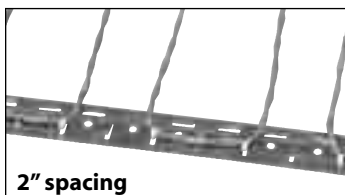

2" spacing

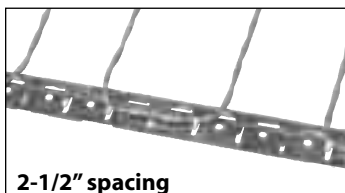

2-1/2" spacing

2-1/2" spacing is achieved by alternating 2" and 3" spacing.

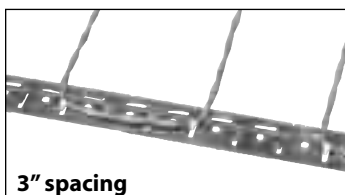

3" spacing

NEVER exceed 3" spacing.

STEP 1.3 Multiply the square footage measured in Step 1.1 by 0.90 to allow for 3" spacing around the edges of the floor area. Use this resulting square footage to select the appropriate cable from the tables on page 4.

Remember:

- Do not place over 15 amps at 120 VAC (1800 watts) or 15 amps (3600 watts) at 240 VAC through a control.
- Select either 120 VAC or 240 VAC depending on the power available. DO NOT mix voltages on the same system if more than one cable is to be installed to cover an area.
- Load no more than 12 amps (1440 watts) on a 15-amp circuit breaker, or 16 amps (1920 watts) on a 20-amp circuit breaker.
- If you have an area that requires more than 15 amps of cables to be controlled by one thermostat, use SunStat Relay(s) to take the additional amp load.
- See the Wiring Diagrams in Appendix 2 for help.

If the exact size of cable calculated is not found in the spool selection tables on page 4, it may be necessary to adjust the warming area(s) or select the next smaller spool size. **Remember, the cable must never be cut shorter to fit, and must be embedded completely in mortar in the floor. Be careful not to select a spool that is too large.**

STEP 1.5 Select enough strap (Order No. 81005523) to secure the cable to the floor. One box contains 25 ft. of strap, enough to prepare about 50 sq. ft. of floor at 4-ft. spacing. Strap is usually spaced every 3 to 4 ft.

Table 1: 120 VAC Spools

Model Number	Total Sq. ft.	Total Sq. ft.	Total Sq. ft.	Wire Length (ft.)	Amperage Draw	Resistance (ohms)
	2" Spacing 15 watts/sq. ft.	2-1/2" Spacing 12 watts/sq. ft.	3" Spacing 10 watts/sq. ft.			
120010WD	8	10	12	47	1.0	112-137
120015WD	12	15	18	71	1.5	78-96
120020WD	16	20	24	94	2.0	58-72
120025WD	20	25	30	118	2.5	44-55
120030WD	24	30	36	141	3.0	34-42
120035WD	28	35	42	165	3.5	29-36
120040WD	32	40	48	188	4.0	25-32
120045WD	36	45	54	212	4.5	22-28
120050WD	40	50	60	235	5.0	20-26
120060WD	48	60	72	282	6.0	17-22
120070WD	56	70	84	329	7.0	14-19
120080WD	64	80	96	376	8.0	12-16
120090WD	72	90	108	423	9.0	11-15
120100WD	80	100	120	470	10.0	10-13

Note: Models ending -J on the UL tag have an additional jacket over the heating cable.

Table 2: 240 VAC Spools

Model Number	Total Sq. ft.	Total Sq. ft.	Total Sq. ft.	Wire Length (ft.)	Amperage Draw	Resistance (ohms)
	2" Spacing 15 watts/sq. ft.	2-1/2" Spacing 12 watts/sq. ft.	3" Spacing 10 watts/sq. ft.			
240020WD	16	20	24	94	1.0	223-274
240030WD	24	30	36	142	1.5	155-191
240040WD	32	40	48	188	2.0	116-143
240050WD	40	50	60	236	2.5	88-109
240060WD	48	60	72	282	3.0	68-84
240070WD	56	70	84	330	3.5	58-72
240080WD	64	80	96	376	4.0	51-63
240090WD	72	90	108	424	4.5	45-56
240100WD	80	100	120	470	5.0	41-51
240120WD	96	120	144	564	6.0	34-42
240140WD	112	140	168	658	7.0	29-36
240160WD	128	160	192	752	8.0	25-32
240180WD	144	180	216	846	9.0	22-28
240200WD	160	200	240	940	10.0	20-26

Note: Models ending -J on the UL tag have an additional jacket over the heating cable.

Example 1. There are 40 sq. ft. of bathroom area to be warmed with 120 VAC. The cable is to be spaced at 2-1/2" to provide 12 watts/sq. ft., providing comfortable warmth across the floor area. As seen in Table 1, use Model Number 120040WD.

Example 2. There are 270 sq. ft. of kitchen and dining area to be warmed with 240 VAC. The cable is to be spaced at 3" to provide 10 watts/sq. ft., providing warmth across the entire floor area. As seen in Table 2, choose Model Numbers 240200WD and 240020WD to end up with about 264 sq. ft. covered.



NEVER bang a trowel or other tool on the heating cable.



Always completely embed the factory splice and all heating wire in mortar. NEVER bend the splice or place any part of it in the wall or through the floor.



Phase 2: Preparation

CAUTION!

As with any electrical product, care should be taken to guard against the potential risks of fire, electric shock, and injury to persons. The following cautions must be observed:

- NEVER** cut the heating cable. The 10-ft. power lead may be cut shorter if necessary, but never removed from the heating cable.
- NEVER** use nails, staples, or similar to fasten the heating cable to the floor.
- NEVER** bang a trowel or other tool on the cable. Be careful not to nick, cut, or pinch the cable causing it to be damaged.
- NEVER** install the cables under cabinets or other built-ins. Excessive heat will build up under these items and cause damage.
- NEVER** install the cable in any walls, over walls or partitions that extend to the ceiling, or in closets.
- NEVER** extend the heating portion of the cable beyond the room or area in which it originates.
- NEVER** attempt to repair a damaged cable. Contact the factory for assistance.
- NEVER** overlap heating cables. Dangerous overheating can occur.
- NEVER** allow a power lead or sensor wire to cross a heating cable; damage could result.
- NEVER** embed the cables in adhesives intended for laminate or vinyl flooring. Cables must be completely embedded in cement-based polymer-modified mortar.
- NEVER** apply the wrong voltage to a cable. Damage can result.
- NEVER** use 1" spacing.

- ALWAYS** completely embed the heating wire and factory splice in mortar.
- ALWAYS** maintain a minimum of 2" spacing between cables.
- ALWAYS** use copper only as supply conductors to the control and the cable. Do not use aluminum.
- ALWAYS** test the cable resistances and record them in the Cable and

ALWAYS

Sensor Resistance Log (page 6).

ALWAYS pay close attention to voltage and amperage requirements of the circuit breaker, control, and the cable system. For instance, do not supply 240 VAC to 120 VAC controls and cables.

ALWAYS make sure all electrical work is done in accordance with local building codes, the National Electrical Code (NEC), especially Article 424, Part IX, and Section 62 of the Canadian Electrical Code (CEC) Part I.

Some Tips

Trowel. Use a plastic trowel(81007407) to reduce the possibility of cable damage.

Insulation. The better insulation that is provided, the more efficiently the system operates, and the better the floor is heated. Concrete slab surfaces offer the most thermal drain and should be insulated before applying the cables, if at all possible. See "Phase 9: Install Insulation" as well as the cross sections in Appendix 1.

Controls. The SunStat™ controls will provide direct floor-warming control for better comfort. Other controls may not give the the same desired level of control. Always select controls that will meet the voltage and amperage ratings of the system and are designed for resistance heating systems.

Mortars. Self-leveling mortars are becoming more popular to use because of their ease of application over the cables. If laying tile, another layer of thin-set will need to be applied in order to lay the tile. Always use polymer-modified cement-based mortar. Do not use solvent-based adhesives or pre-mixes because they are not as heat resistant.

LoudMouth™. The LoudMouth sounds an alarm if damage occurs to the cable during installation. The LoudMouth stays connected to the power leads throughout cable and tile installation. A small screwdriver for connecting the leads is included with the LoudMouth monitor.

**Items Needed****Materials:**

- WarmWire system
- CableStrap
- Thermostat control with floor sensor (SunStat)
- 20-amp circuit breaker (single for 120-VAC and dual for 240-VAC systems)
- Electrical box (extra deep) for the control; single-gang (not a gangable type) or 4"-square deep box with a single-gang "mud ring" cover
- 4" junction box with a cover, if needed
- Cable clamps for junction box (for new construction)
- Flexible or rigid conduit (for new construction)
- 12-gauge or 14-gauge electrical wiring cable (consult local code)
- Wire nuts if using a junction box
- Nail plate
- Polymer-modified cement based mortar

Tools:

- Digital multi-meter [for ohms testing; must read up to 20,000 ohms (Ω) to measure sensor]
- Drill with 1/2" bit
- Hammer and chisel
- Wire strippers
- Phillips screwdriver
- Fish tape (for existing construction)
- Hole saw (for existing construction)
- Trowel (81007407-plastic preferred) with 3/8" notches (or greater)

Floor covering installation tools:

- Book or video on electrical wiring techniques, but professional connection is recommended.
- Book or video on floor covering installation techniques

STEP 3.1**STEP 3.2****Phase 3: Inspect the Cable and Sensor**

STEP 3.1 Take the cable out of the box and inspect it to make sure there is no visible damage. There are shielded leads coming out of the spool of cable called the "power leads" (they are simply power supply cables that do not heat). The power leads are approximately 10 ft. long and will connect the heating cable to the control for power.

STEP 3.2 Record the product information. There is a factory-applied nameplate label on the power leads. Do not remove this label. Record the cable serial number, model number, voltage, and cable resistance range in the Cable and Sensor Resistance Log (page 6). If installing more than one cable, do this for each of them.

STEP 3.3



IMPORTANT! To retain the Limited Warranty, the following measurements must be recorded, and all steps of this manual followed.

STEP 3.3 Take resistance readings of the cable and floor sensor to make sure they are not damaged. It is very important that this be done throughout the entire installation process. Use a quality digital ohmmeter or multimeter [able to measure up to 20,000 ohms (Ω)] to make these measurements. Analog meters (that use a moving needle) are not accurate for this product and should not be used.

Take resistance readings (1) before beginning the installation, (2) after the cable and sensor are fastened to the floor, and (3) after floor coverings are installed. Checking these measurements frequently during finished floor installation is strongly recommended in order to avoid burying a damaged cable.

Check for Breaks

Measure resistance between the black and white cable leads (black and blue leads for 240-VAC cables) and record this in the chart below. This measurement should be within the cable resistance range shown on the nameplate label. Measure between the lead wires of the floor sensor. This resistance varies according to the temperature sensed in the tip. The sensor resistance table at left provides approximate values for comparison. A cut or break in the wire is indicated by a resistance of “infinite” ohms (no continuity).

Check for Short-Circuits

Measure resistance between the black and ground leads and between the white and ground leads (blue and ground leads for 240-VAC cables) and record this value below. These measurements should be “infinite” ohms (no continuity). A cut or pinch in the wire is typically indicated by a resistance value less than the cable resistance range.

Floor Sensor Resistance Values

Temperature	Typical Values
55°F (13°C)	17,000 ohms
65°F (18°C)	13,000 ohms
75°F (24°C)	10,000 ohms
85°F (29°C)	8,000 ohms

Cable and Sensor Resistance Log

	CABLE 1	CABLE 2	CABLE 3
Cable serial number			
Cable model			
Cable voltage			
Factory cable resistance range			
OUT OF THE BOX BEFORE INSTALLATION (ohms)			
Cable black to white			
Cable black to ground			
Cable white to ground			
Sensor wire			
AFTER CABLE AND SENSOR ARE FASTENED TO FLOOR (ohms)			
Cable black to white			
Cable black to ground			
Cable white to ground			
Sensor wire			
AFTER FLOOR COVERINGS ARE INSTALLED (ohms)			
Cable black to white			
Cable black to ground			
Cable white to ground			
Sensor wire			

RETAIN THIS LOG TO RETAIN THE WARRANTY! DO NOT DISCARD!

STEP 4.2

Install an extra-deep single-gang box if connecting one or two cables to the control. Use a 4"-square deep box with a single-gang mud ring cover if connecting three cables, because the extra room is needed for the wire, wire nuts, and control.

Phase 4: Electrical Rough-in

See wiring diagrams in Appendix 2 for different voltages and applications. For additional help see www.suntouch.com.

New Construction (see below for existing construction)

OVERVIEW We recommend the floor-warming system be installed on a dedicated circuit coming directly from the circuit breaker panel. Follow all National Electric Code (NEC) and other local electrical code requirements when installing this system. Work should be done with great care and with the power turned off to the circuit being worked on.

STEP 4.1 Install a maximum 20-amp circuit breaker(s) into the breaker panel, depending on the load of the system. Use a 120-VAC single-pole breaker for a 120-VAC system. Use a 240-VAC double-pole breaker for a 240-VAC system. Use a Ground Fault Circuit Interrupter (GFCI) type if not using our controls (which have a built-in GFCI).

For systems that are too large to directly power through one control but must be operated by one floor-sensing control, use a SunStat control in combination with up to 10 SunStat Relay Controls. Contact a SunTouch dealer or the factory for more information.

STEP 4.2 Install an electrical box for the control. If installing one to two cables, use an extra-deep single-gang box to allow plenty of room for the wiring. Use a 4"-square box if installing three cables. The box can be located almost anywhere that is well ventilated. However, the best place is in the same room as the cable, typically about 60" above the floor, and within reach of the power lead wires of the cable. If installing more than three cables, it will be necessary to connect their power leads in a junction box first (see Step 4.4) to keep from overfilling the control electrical box. Then route one power supply from this junction box to the control box.

See Step 5.23 for special requirements if the control will connect to a heating cable entering a shower area.

STEP 4.3 Following code, feed 14- or 12-gauge NM type electrical wiring from the circuit breaker panel to the control electrical box. Leave about 6"-8" of extra wire extended from the box to work with.

STEP 4.4 If the control box must be mounted in a location that is too far to reach with the power lead wires, it will be necessary to mount a junction box where the lead wires can be terminated. Use a standard junction box with a cover, mounting it below the floor, in the attic, or in another easily accessible location. It must remain easily accessible and not located behind a wall, cabinet, or similar obstruction. Then use 14- or 12-gauge NM type or other accepted electrical wiring to connect from the junction box to the control box.

STEP 4.5 Drill two 1/2" holes in the baseplate directly below the control electrical box. Then, as close to the floor surface as possible, drill two horizontal holes, intersecting the top holes.

STEP 4.6 If conduit is required by local electrical code, cut a length of 1/2" to 3/4" electrical conduit to run from the control box down to the baseplate. At the baseplate it may be necessary to chisel out more of the wood to make it easier to feed the wires up through the conduit.

STEP 4.7 Mark the circuit breaker in the panel which feeds the system with "Floor warming/bath" or similar description.

Existing Construction

OVERVIEW It is recommended that the system be installed on a separate, dedicated circuit coming directly from the breaker panel. In existing construction, however, it may be difficult to do this depending on the location of wiring and the breaker panel. Tapping off an existing circuit may be possible, but only if there is enough load capacity to handle both the system and any additional loads that may be placed on the circuit. Keep in mind that typical hair dryers can pull up to 10 amps (1200 watts) of load.

Follow all NEC and other local electrical code requirements when installing this system. Work should be done with great care and with the power turned off to the circuit being worked on.

STEP 4.5

STEP 4.9**STEP 4.10****STEP 4.11****STEP 4.12****STEP 5.3**

STEP 4.8 Install a maximum 20-amp circuit breaker(s) into the breaker panel, depending on the load of the system. Use a 120-VAC single-pole breaker for a 120-VAC system. Use a 240-VAC double-pole breaker for a 240-VAC system. Use a Ground Fault Circuit Interrupter (GFCI) type if not using one of our controls (which have a built-in GFCI).

For systems that are too large to directly power through one SunStat but must be operated by one floor-sensing control, use a SunStat Control in combination with up to 10 SunStat Relay Controls. Contact a SunTouch dealer or the factory for more information.

STEP 4.9 Cut an opening in the wall for the control electrical box. If installing one to two cables, use an extra-deep single-gang box to allow plenty of room for the wiring. Use a 4"-square box if installing three cables. The box can be located almost anywhere that is well ventilated. However, the best place is in the same room as the cable, typically about 60" above the floor, and within reach of the power lead wires of the cable. If installing more than three cables, it will be necessary to connect their power leads in a junction box first (see Step 4.11) to keep from overfilling the control box. Then route one power supply from this junction box to the control box. See Step 5.23 for special requirements if the control will connect to a heating cable entering a shower area.

STEP 4.10 Following code, feed 14- or 12-gauge NM type electrical wiring from the circuit breaker panel to the control electrical box opening. Leave about 6"–8" of extra wire extended from the opening.

STEP 4.11 If the control box must be mounted in a location that is too far to reach with the power lead wires, it will also be necessary to mount a junction box where the lead wires can terminate. Use a standard junction box with a cover, mounting it below the floor, in the attic, or in another easily accessible location. It must remain easily accessible and not located behind a cabinet or similar obstruction. Then use 14- or 12-gauge NM type or other accepted electrical wiring to connect from the junction box to the control electrical box.

STEP 4.12 At the floor level below the control box, cut a 2"x 2"-wide piece from the wall surface. Use a wood chisel to notch out a channel in the baseplate to make it easier to route the wires up the wall.

STEP 4.13 Mark the circuit breaker in the panel which feeds the system with "Floor warming/bath" or similar.

Phase 5: Install the Cables

Getting Started

IMPORTANT! Refer to Phase 8 and Appendix 1 to make sure the floor is properly prepared for installation of the cable(s), especially the use of reinforcement, leveling, and insulation on concrete slab.

STEP 5.1 Use the sketch and design considerations made earlier in Phase 1 to begin laying the cables. Do not install the cables closer than about 6" from wax toilet rings and plumbing to keep from overheating these items.

STEP 5.2 Make sure to space the cables to provide the warmth desired. **NEVER** space them at 1" apart because this will cause a very hot area and may damage the system. Before installing the cables, make certain the proper cable length and voltage has been selected for the square footage to be heated.

STEP 5.3 If this is new construction, draw lines on the floor or use templates to outline the area of any cabinets, fixtures, or future walls that will be placed in the room. **NEVER** install the cables under cabinets, fixtures, or walls. Excess heat may build up under these items and cause damage.

STEP 5.4 Decide which direction the cables will run on the floor for the easiest coverage. Refer to the sample layouts in this manual for assistance. Depending on the shape of the area, it may help to think of it in terms of several smaller areas.

NEVER cross the cables over each other or cut them shorter. Damage

NO! **NEVER** use 1" spacing

NEVER use less than 2" spacing.

STEP 5.5

may result and may cause dangerous problems. Extra forethought at this stage will make the rest of the installation much easier.

General Installation

STEP 5.5 Measure about 3" from the wall for the strap. If the design called for 6"-12" away from the wall, install the strap at that distance. In counter or vanity kick-spaces, install the strap so the cable will be 1-1/2" to 2" away from the vanity.

STEP 5.6 Cut the strap to fit the length of the first area.

STEP 5.6

STEP 5.7 Secure the strap to the floor using double-sided tape (if factory supplied with your cables), or using a strong spray adhesive (such as 3M™ Hi-Strength 90 or similar), spray an even coat onto the backside of the strap and the area of floor where it will be placed, allow the adhesive to get tacky (per product instructions), then turn the strap over and firmly press onto the floor. Follow all manufacturer's instructions when using a spray adhesive.

STEP 5.7

STEP 5.8 For floor surfaces other than concrete, secure the strap to the floor using galvanized nails or screws. Secure the strap every 6"-10".

STEP 5.9 For added securement, on concrete floors, use a hammer drill to set holes into the concrete. Secure the strap every 6"-10" by driving anchors into the holes.

STEP 5.10 Cut another piece of strap for the other end of the area and secure 3" from the wall(s) or other obstruction(s).

STEP 5.11 Unreel the power leads of the cable up to the factory splice. Let the coil of power leads sit on the floor for now. Beyond the factory splice is the heating cable itself. Factory splice must be installed in the mortar bed. **CAUTION: Completely embed the factory splices and heating cable in the mortar, and never bend the factory splices. NEVER allow any part of the splice or heating cable to enter a wall or drop through the subfloor.**

STEP 5.8

STEP 5.12 Before installing more strap, fill in the first section with cable. Begin by making a "strain-relief" at the beginning so the cable is not accidentally pulled loose. Zigzag the cable under the tabs only as shown. Press the tabs down to secure the cable.

STEP 5.9

STEP 5.13 Weave the cable back and forth across the area at the desired spacing until the other side of the room has been reached. Once this area is completed, press down all the tabs. **NEVER** space the cables less than 2" apart.

STEP 5.14 If there are additional areas to cover with cable, cut the lengths of strap necessary, attach them to the floor, and begin weaving the cable into that area.

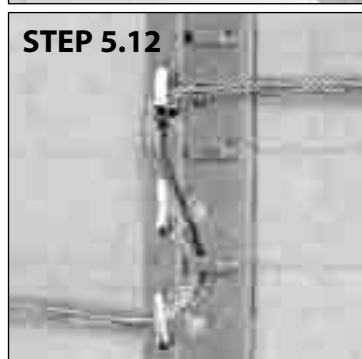
STEP 5.10**STEP 5.11****STEP 5.12****STEP 5.13**



STEP 5.15

Other Installations

Because many different room shapes and floor obstructions may be encountered in any given installation, additional layouts are provided below to assist in determining the best way to complete installations in odd-shaped areas.

Corner shower or vanity

STEP 5.15 For an angled area, such as a corner shower, first cut several pieces of strap a little longer than the cable spacing being used.

STEP 5.16 Use a chalk line or pen to mark the floor at 3" from the edge of the shower.

STEP 5.17 Use this chalk line to attach each piece of strap to the floor so that the cable does not get any closer to the corner shower than 3". Make sure that the cables are spaced evenly and parallel to one another.

STEP 5.18 Fill in the section with cable.



STEP 5.16



STEP 5.17



STEP 5.18



STEP 5.19

Door entryway

STEP 5.19 For an entryway or other small area where warmth is required, begin by cutting two lengths of strap a little shorter than the length of the entry opening. Then secure the two straps parallel to each other.

STEP 5.20 Fill in with cable, adjusting spacing as necessary to fill in as much of the area as possible.

Bench Seat

STEP 5.21 If covering a bench seat or step area (not in a shower area), place a single run up the riser. Use straps to secure the cable to the seat area at the desired spacing, then install a single run down the riser. Again, the cable on the riser and seat area **MUST** be fully embedded in mortar and have approved floor coverings. Use hot glue where necessary to secure the cable flat against the riser.

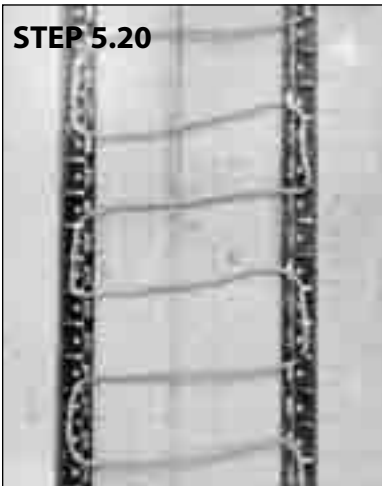

STEP 5.20

Shower area installation

Model Numbers ending "-J" on the UL tag only:

This application into a shower area must be verified by the local inspector or the authority having jurisdiction. (UL Listed to U.S. Standards only at this time for this application.)

STEP 5.22 "UL tag -J" series cable may be installed into a floor or bench seat located in a shower area. It must never be installed into walls. In general, the cable should be completely embedded into mortar directly below the surface coverings of tile or stone. Other types of coverings are not recommended. It may be installed into a mortar layer lower than this and beneath the waterproof system, however performance will be reduced.

STEP 5.23 Make sure the power lead factory splice (the connection between the power leads and the heating cable) is located outside the shower area and at least 1' away from shower openings and other similar areas normally exposed to water. Make sure the control is located at least 4' away from shower openings such that it cannot be exposed to water or touched by a person in the shower area.

STEP 5.24 If the heating cable must enter the shower area over a curb, notch the corners of the curb or provide other means to ensure the cable is not bent sharply or pinched when surface coverings are installed. Do not damage any waterproofing components, and do not run the heating cable through the curb.

STEP 5.25 If covering a shower floor, cut lengths of strap and secure to

the floor with adhesives. Do not use fasteners that penetrate any waterproofing membrane or waterproofing system. Fill in the floor area with cable. Around the drain leave at least 2" spacing from the edge of the flange. Make sure cable is not placed where door hardware, handrails, or other items may mount to the floor.

STEP 5.26 If covering a bench seat in the shower, cut lengths of strap and secure to the top surface of the seat with adhesives. Do not use fasteners that penetrate any waterproofing membrane or waterproofing system. Use hot glue to secure a single run of cable up the side of the bench riser. Fill in the seat area with cable. Then secure a single run of cable down the riser if needed.

STEP 5.27 If the cable cannot exit the shower area, the end of the cable has a waterproof splice that may be located in the shower area, fully embedded into the mortar like the heating cable.

STEP 5.28 If any part of the heating cable entering a shower area is damaged during installation, **do not attempt to repair it**. A field repair or modification of the cable may result in serious shock hazard.

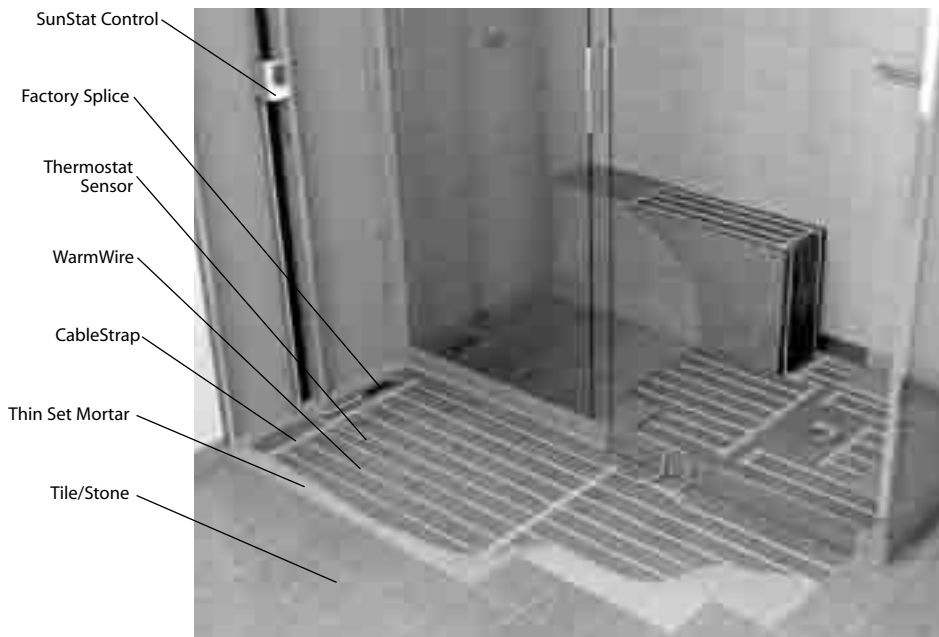

WarmWire models ending in "-J" on the UL tag can be installed in shower floors and/or benches.

Final Steps

STEP 5.29 If a second cable is to be installed in the area, all power leads must come back to the control, or to a junction box and then to the control. *NEVER* run power leads across heating cables, under baseboard areas, or other potentially damaging areas. Never join two cables in series.

STEP 5.30 To secure long lengths of heating cable, place additional, short lengths of the strap at 3–4-ft. intervals. Spray the back of the strap with a high-tack adhesive, and slide the strap, upside down, under the cables. Turn the strap over when it is positioned and adhere to the floor. Press the tabs down over the cables. If a spray adhesive was not used, carefully secure these short lengths of strap to the floor without damaging the cable.

STEP 5.31 After the cable installation is completed, inspect the work. Make sure all tabs are pressed down, cable spacings are correct, no cables cross over each other, all the cables are undamaged, and all areas to be heated are covered with cable.

STEP 5.32 Take resistance readings of the cable again to make sure it has not been damaged during the installation. This is very important to do. Record these readings in the Cable and Sensor Resistance Log (page 6).

STEP 5.33 (optional) With the heating portion of the cable fully installed, it is recommended that the cable be temporarily connected to the power source and allowed to heat for several minutes. After the cables begin to feel warm to the touch, disconnect the power.

STEP 5.34 Lay cardboard, carpet, or similar material over the cables to protect them from damage until the floor covering is installed.

STEP 6.1**STEP 6.3****STEP 6.5****STEP 6.8****STEP 6.11**

Phase 6: Finish Wiring

STEP 6.1 Chisel a channel into the floor to lay the factory splice into. This will ensure the splice does not create a high-spot in the floor. **CAUTION: The power lead splice MUST BE FULLY EMBEDDED IN the mortar bed and never bend the factory splices. NEVER allow any part of the splice or heating cable to enter a wall or drop through the subfloor.**

New Construction

STEP 6.2 Feed the power leads from the cable up through the hole drilled in the baseplate, or up into the conduit to the control electrical box (or junction box if one was used).

STEP 6.3 Secure the power lead splice into the chiseled channels with hot-glue.

STEP 6.4 Below the control, or wherever the floor sensor is to be located, measure at least 1 ft. into the heated area. Mark the spot where the sensor will be attached to the floor. Be sure to locate the sensor exactly between two of the heating cables.

STEP 6.5 To make sure the sensor tip does not create a high spot in the floor, chisel a channel into the floor and lay the sensor tip into the channel. Hot glue the tip into place.

STEP 6.6 Drill another hole into the baseplate, if needed, to feed the sensor wire up to the control box. Finish by securing a steel nail plate over the wires to protect them against baseboard nails later.

STEP 6.7 If it was necessary to end a power lead at a junction box, feed 14- or 12-gauge electrical wire from this box to the control box.

Tip: If more than one cable was installed, label the ends of the power leads with a brief description as to which area they supply power. Use tape to label them "Cable 1," "Cable 2," "Kitchen," "Bath," or similar. This will make it easier to identify the leads later on. Take photos of the installation. This will provide a useful record for any future needs.

Existing Construction

STEP 6.8 Use a fish tape to pull the power leads up the wall to the control electrical box (or junction box if one was used).

STEP 6.9 Secure the power lead factory splice into the chiseled channel with hot-glue (see photo for Step 6.3).

STEP 6.10 Below the control, or wherever the floor sensor is to be located, measure at least 1 ft. into the heated area. Mark the spot where the sensor will be attached to the floor. Be sure to locate the sensor exactly between two of the heating cables (see photo Step 6.4). To make sure the sensor tip does not create a high spot in the floor, chisel a channel into the floor and lay the sensor tip into the channel. Hot glue the tip into place (see photo Step 6.5).

STEP 6.11 Use a fish tape to pull the sensor up the wall to the control electrical box, and finish by securing a steel nail plate over the power leads and sensor wires to protect them against baseboard nails.

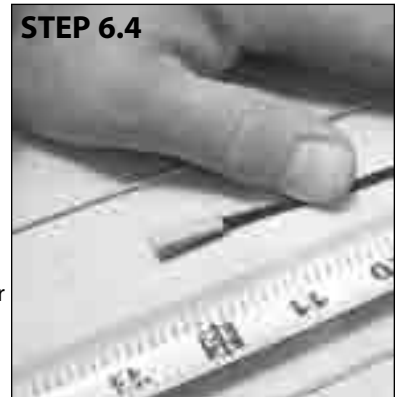
STEP 6.4**STEP 6.6**

STEP 6.12 If it was necessary to end a power lead at a junction box, feed 14- or 12-gauge electrical wire from this box to the control box.

Tip: If more than one cable was installed, label the power leads with a brief description as to which area they supply power. Use tape to label them "Cable 1," "Cable 2," or "Kitchen," "Bath," or similar. This will make it easier to identify the leads later on. Take photos of the installation. This will provide a useful record for any future needs.

Phase 7: Install the Control

STEP 7.1 Read and follow the instructions that come with the SunStat controls.

STEP 7.2 Refer to the wiring diagrams in this manual for different voltages and applications.

STEP 7.3 Install the electrical box for the control, if this has not already been done. Connect the power leads from the cable (or the electrical wiring coming from junction boxes) to the "LOAD" side of the control. Connect the incoming power to the "LINE" side of the control. Connect the sensor wires to the sensor terminals on the control. Connect the ground leads from the system to the ground wire from the incoming power.

STEP 7.4 Install the control into its electrical box and turn the circuit breaker on to power the system. Test the system and control for several cycles. It should allow the heating cables to heat up correctly. Note: Consider placing a loose tile over the sensor tip to simulate warming the floor and allow the sensor to register this on the control.

STEP 7.5 Retain all instruction sheets and warranties.

Phase 8: Install the Floor Coverings

STEP 8.1 *Make a Final Inspection of the Installation.* Inspect the installation very carefully for evidence of damage or missing sensor(s).

STEP 8.2 *Select Type of Construction.* Choose the best thin-set, thick-set, or self-leveling mortar method for the application. See Appendix 1 regarding final floor installation techniques. Consult with building professionals and/or the factory if assistance is required.

STEP 8.3 *Take Another Resistance Reading!* After floor coverings have been installed, take resistance readings of the cable again to make sure it has not been inadvertently damaged. This is very important to do. Record these readings in the Cable and Sensor Resistance Log (page 6).

Phase 9: Install Insulation

Insulate under the subfloor for better performance and efficiency of the system. Refer to the Appendix 1 for diagrams and insulation recommendations.

Phase 10: System Operation

After all system components are in place and floor coverings installed, briefly test the operation of the system but do not put the system into full operation until the mortar materials are fully cured (typically one to four weeks). See the mortar manufacturer's recommendations for the specific type of mortar used.

Many manufacturers of laminate and wood flooring recommend a maximum of about 84°F (29°C) on the floor surface. Be sure to program the control accordingly. Consult the manufacturer regarding recommended floor temperatures for the flooring being installed.

Energize the system. Operate the controls so that the system turns on the floor-warming cable. The control will normally indicate that power is being supplied to the cable. It will take some time for the cable to warm up. Using a clamp-type ammeter (electricians normally carry these), pull the control out of the wall and determine whether the cables are pulling current, thus indicating they are working as intended. Turn the system off after NO MORE than 10 minutes of operation. Do not operate the system again until the floor mortar is cured. Once the flooring is completely cured, the control can be used to operate the system for many years to come.

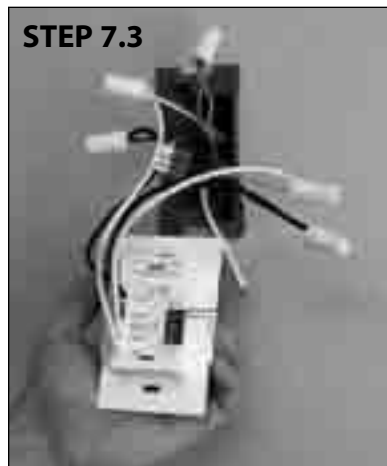

Troubleshooting Guide

If not qualified to perform electrical installations, it is strongly recommended that a qualified, licensed electrician be hired to install the heating cables and related electrical components. If problems with the system arise, please consult the troubleshooting guide below. Any troubleshooting work should be done with the power removed from the circuit, unless otherwise indicated. Call the factory or see www.suntouch.com for further assistance.

Problem	Possible Cause	Solution
Cable resistance measurement is outside the range printed on the nameplate label.	An analog ohmmeter (using a moving needle) was used to take the reading.	Obtain a digital ohmmeter able to read 0 to 20,000 ohms and remeasure the resistance.
	If measurement shows an open or short circuit, the cable has been damaged.	Record resistances between all wires and contact the manufacturer.
	If measurement is just a little low or high, room temperature has affected the resistance.	Make the room temperature 65°–75°F, or contact the manufacturer.
	The resistance measurement could be from more than one cable wired in series, or wired in parallel. Either will provide false resistance readings.	Make sure resistance measurements are for only one cable at a time. When connecting more than one cable to the control, multiple cables must be wired in parallel (i.e., black to black, white to white).
	The ohmmeter may be set to the wrong scale. For instance, the 200 K ohms scale measures up to 200,000 ohms.	The ohmmeter should typically be set to the 200 ohms scale, with the exception of cables having a rating above 200 ohms on their nameplate label. If the resistance reading is outside the range printed on the nameplate label, contact the manufacturer.
Floor does not get warm.	Cable has been damaged.	Measure cable resistance. Check for both “open circuit” and “short circuit” as detailed earlier in this manual. If damaged, record resistances between all wires and contact the manufacturer.
	GFCI has tripped, indicated by a light on the control or “GFCI TRIP”.	Check for loose wire connections. Reset the GFCI on the control or circuit breaker. If it trips again, check for a short circuit in the cable as detailed earlier in this manual. If cable is damaged, record resistances between all wires and contact the manufacturer. If cable is not damaged, replace the GFCI control. Also see “GFCI conflicts” below.
	Incorrect voltage supplied, or mismatched electrical components used.	Measure “line” voltage, 120V cables have black and white leads. 240V cables have black and blue leads.
	Concrete slab floor.	Surface temperatures rise slowly in a slab. If, after 5 to 8 hours of heating, the floor is not warmer to the touch, check for cable damage (see “Cable has been damaged” above). Measure “load” voltage/ampereage to cable.
	Cables are wired in “series” or “daisy chained” (end-to-end).	Multiple cables must be connected in “parallel” (or black-to-black, white-to-white).
Floor heats continuously.	Incorrect wiring. The control was “bypassed” when it was wired to the power supply.	Make sure wiring connections are correct. Consult the wiring diagram on the back of the control, the instructions that came with the control, or the wiring diagrams in Appendix 2.
	Defective control.	Return control to dealer for replacement.
Floor temperature shows “HI” or may show temperature over 100°F.	Floor sensor is not wired properly, or is located incorrectly.	Make sure only one floor sensor is connected to the control. Also see “Sensor is loose or broken” above.
Control is not working correctly.	If a programmable control, the programming may be incorrect.	Carefully read and follow control programming instructions.
	Incorrect voltage supplied, or mismatched components used.	Test voltage, verify parts. See “Incorrect voltage supplied” above.
	Floor sensor is not wired properly, or is not working properly.	Make sure only one floor sensor is connected to the control. Also see “Sensor is loose or broken” above.
	Loose connection(s) on line side and/or load side of control.	Remove and reinstall the wire nuts at each connection. Make sure the wire nuts are tight. Check all connections back to the breaker.
	Defective control.	Return control to dealer for replacement.
Control is not working at all.	No power is supplied.	Check circuit breaker. Measure voltage at the control. Check all connections between breaker and control.
	Floor sensor is not wired properly, or is not working properly.	Make sure only one floor sensor is connected to the control. Also see “Sensor is loose or broken” above.
	Defective control.	Return control to dealer for replacement.
GFCI conflicts and false-trips.	More than one GFCI on the circuit.	GFCI units sometimes trip when there is nothing wrong with the equipment on the circuit, but when there is more than one GFCI. Reroute power to avoid having more than one GFCI on the circuit.
	An electric motor or a ballasted light source is sharing the circuit with the cable(s).	Electric motors and other electrical devices can cause a GFCI to false-trip. Run a dedicated circuit to the floor-warming system.

Appendix 1: Types of Construction and Applications

The cross sections on these pages depict types of construction (slab vs. frame floor) and applications commonly used in the installation of the cable. Choose the best installation detail for the particular construction and application.

Slab Construction and Applications

Insulation. In new slab construction, it is highly recommended that foam insulation be installed under and around the slab to prevent loss of radiant heat into the surrounding soil.

In existing construction where insulation under the slab is absent, it is strongly recommended that a layer of insulating material be attached to the slab prior to the installation of the cable.

Cork, for example, possesses a minimal R value that will help keep the radiant heat at the floor surface. Consult the cork manufacturer regarding proper application and attachment of the cork to the concrete slab. There are other options for insulation as well.

Antifracture membrane. While optional, it is recommended that an antifracture membrane be installed directly to the slab or the self-leveling mortar layer underneath the tile. This flexible layer reduces the chance of minor stress and fracturing in the slab from being transmitted upward to the tile.

Reinforcement. To further strengthen the floor, consider laying a 1-1/4" to 2" mudbed, reinforced with metal or plastic lath, directly onto the optional antifracture membrane. Then install the cable(s).

Framed Floor Construction and Applications

In framed-floor construction, the two primary concerns are insulation and floor rigidity. Without proper insulation, radiant heat leaks into the joist spaces. And unless the plywood subfloor is properly reinforced, stresses in the subflooring can cause unsightly cracking in the tile floor.

Insulation. The use of insulation in the joist spaces dramatically enhances the performance and efficiency of the floor-warming system. Insulation with an R value of 19 will

SLAB

Construction and Applications

Thin-set mortar over slab

(Dry-set or latex cement on slab; TCA #RH115-03)

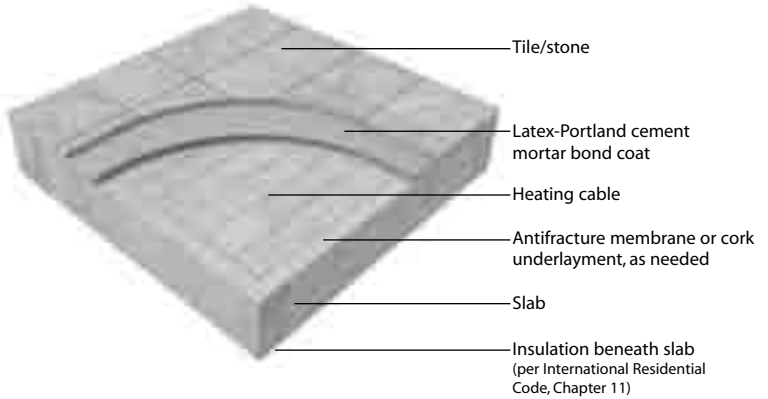

Thick-set mortar bed over slab

(Cement mortar bonded; TCA #F112-03)

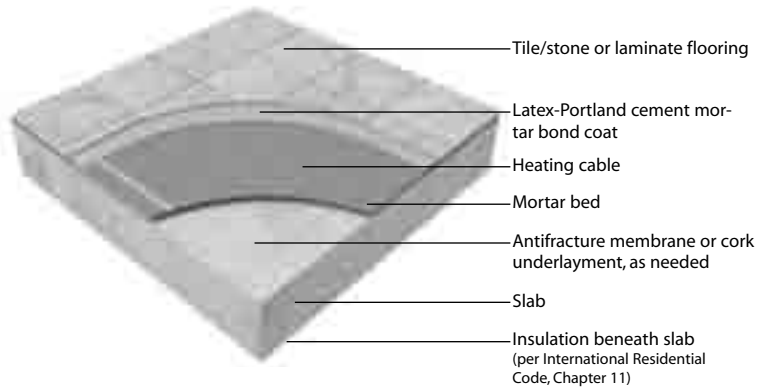

Self-leveling mortar over slab on grade

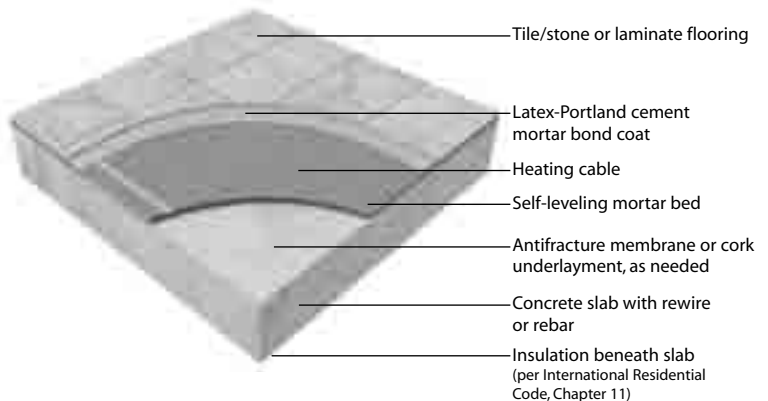

be sufficient for most regions, while in more temperate areas R-11 will suffice.

Do not install rigid insulation layers directly above or below backer board or mortar. If possible, install insulation as shown in the diagrams at right.

Reinforcement. There are several options for strengthening the sub-floor:

1. Add 3/4"-thick plywood on top of the existing subfloor.
2. Pour a 1/4"-1/2"-thick layer of self-leveling mortar over the existing subfloor, then install the cables on top of the mortar layer.
3. Install a quality cementitious backer board or fiber cement underlayment over the subfloor. Then install the cable and lay the tile.

Antifracture membrane. While optional, it is recommended that an antifracture membrane be installed to reduce the chance of minor stress and fracturing in the subflooring from being transmitted upward to the tile. If an antifracture membrane is used, install the cable above the membrane, unless otherwise recommended by the membrane manufacturer.

In place of an antifracture membrane, an uncoupling system can be installed to prevent deflection in the subfloor from affecting the tile surface.

Mortar Beds

The cables can be installed in three types of mortar beds: thin-set or thick-set mortar beds 3/8" to 1" thick, and self-leveling mortar beds 1/4" to 1/2" thick.

Thin-set Mortar Beds. If the cable will be placed directly onto the slab, or if backer board or plywood reinforcement is used on a plywood sub-floor, first install the cable then apply the thin-set mortar bond coat directly over the cable and lay the tile.

Thick-set Mortar Beds. If a thicker mortar bed is used to strengthen the floor, the cable can be installed under either the mortar bed (also known as "dry-set") or under the mortar bond coat directly below the tile or stone. In a thick-set application, the cable is generally installed above the mortar bed, but before the thin-set bond coat. Thick mortar beds of this type require the use of a reinforcing mesh or lath.

FRAMED FLOOR

Construction and Applications

Thin-set mortar over framed floor

(Dry-set or latex cement mortar; TCA #F144-03)

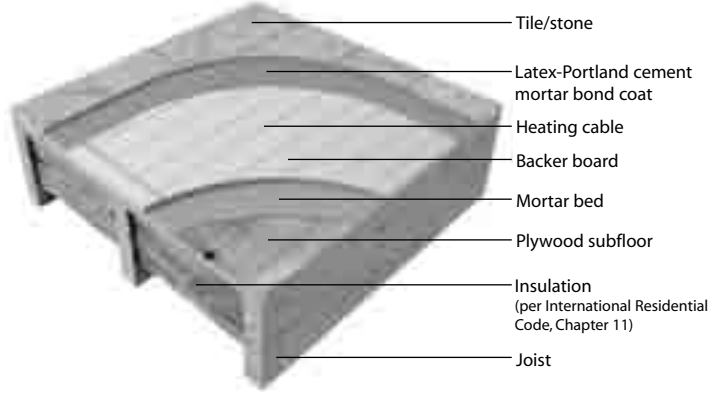

Thin-set mortar over framed floor

(Dry-set or latex cement mortar; TCA #RH130-03)

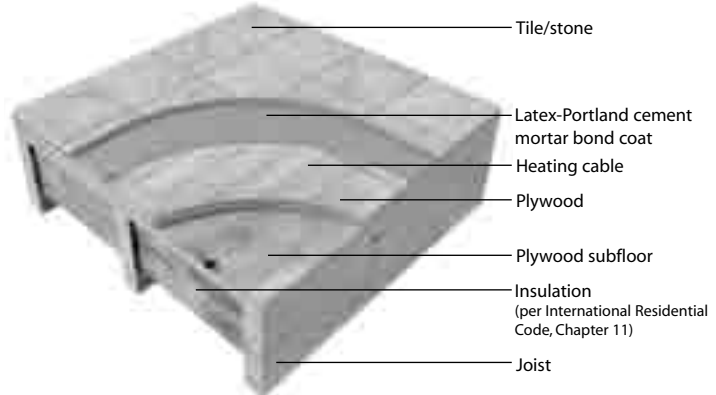

Thick-set cement mortar with lath

(Cement mortar metal lath; TCA #145-03)

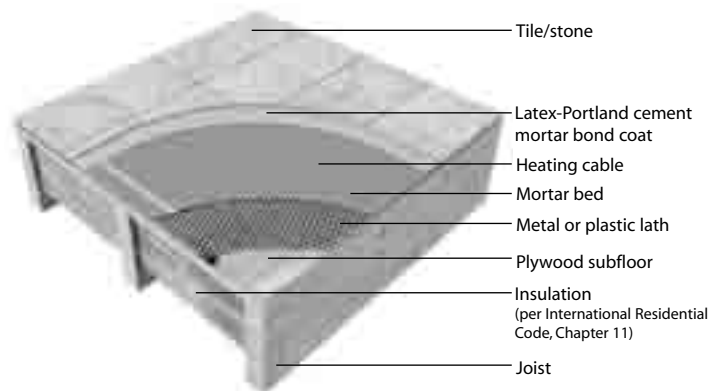

If plastic lath is used instead of the typical metal lath, the cable can be installed before pouring the self-leveling mortar bed.

CAUTION: If metal lath is used in the mortar bed, do not allow the cable to come in direct contact with the lath. Damage to the cable could result.

Self-leveling Mortar Beds. Self-leveling mortar beds are appropriate if installing non-masonry floor coverings such as engineered wood, vinyl, laminate, or carpet. Attach the cables to the slab or subfloor, then pour a 1/4"–1/2"-thick layer of self-leveling mortar over the cables according to manufacturer's specifications. Install the floor coverings after the mortar has cured.

Regardless of the type of mortar bed used in any particular application, always secure the cable to the floor first, then cover it with the mortar or cement. Never attempt to lay or work the cable into a previously-poured layer of wet mortar.

It is strongly recommended that tile and stone flooring be installed according to manufacturer's recommendations, Tile Council of North America (TCNA) guidelines, and ANSI specifications. Follow industry and manufacturer's recommendations when installing non-masonry floor coverings, such as hardwood, vinyl, laminate, or floating floors.

Other Considerations

Expansion joints. In slab or mortar applications, do not install the cables through an expansion joint unless an appropriate antifracture membrane is installed per TCA recommendations. If not using an antifracture membrane, install the cables right up to the joint, if necessary, but not through the joint.

Mosaic tile. When laying mosaic tile, first embed the cables in the appropriate mortar bed as shown in the diagrams on the previous pages, and allow to cure per manufacturer's instructions. Then thin-set the mosaic tile according to typical practice.

REMEMBER: If in doubt about any aspect or phase of the installation, consult with building professionals and/or the manufacturer regarding specific installation details before beginning.

Appendix 2: Typical Electrical Wiring Diagrams (120 and 240 VAC)

Typical Electrical Wiring Diagram with SunStat Control (120/240VAC)

Dedicated 120 or 240VAC, 20-amp (maximum) circuit.

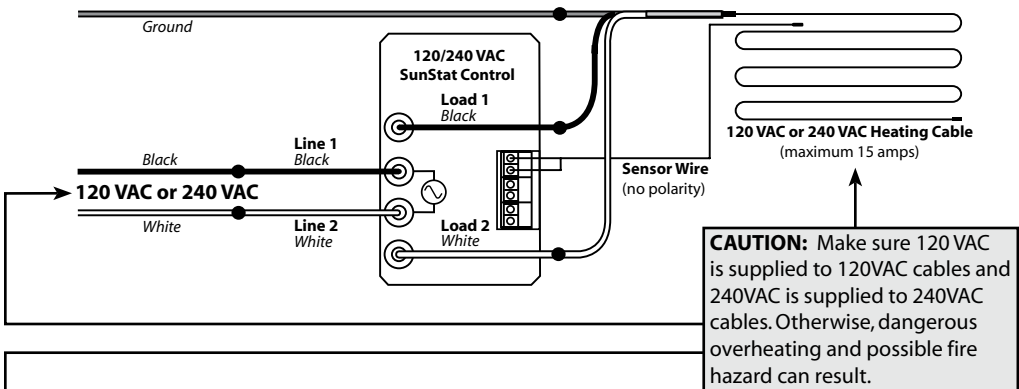

Typical Electrical Wiring Diagram with SunStat Control (120/240VAC)

Dedicated 120 or 240VAC, 20-amp (maximum) circuit.

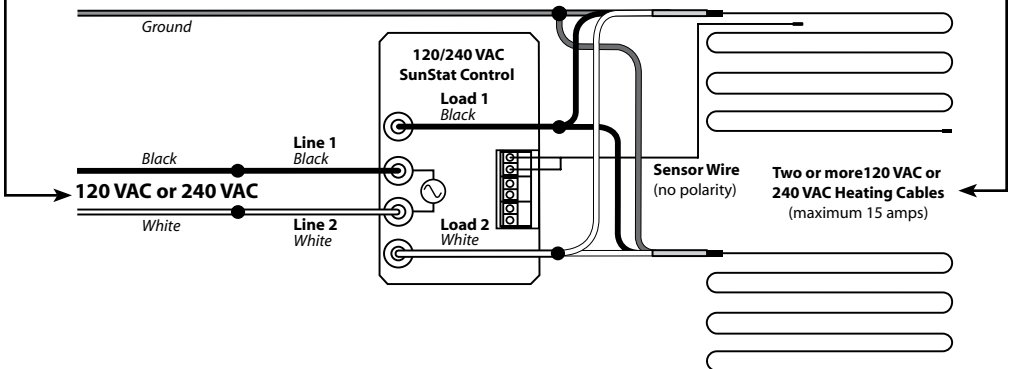

Typical Electrical Wiring Diagram with SunStat Control and Relay(s)

Dedicated 120VAC or 240-VAC, 20-amp (maximum) circuit.

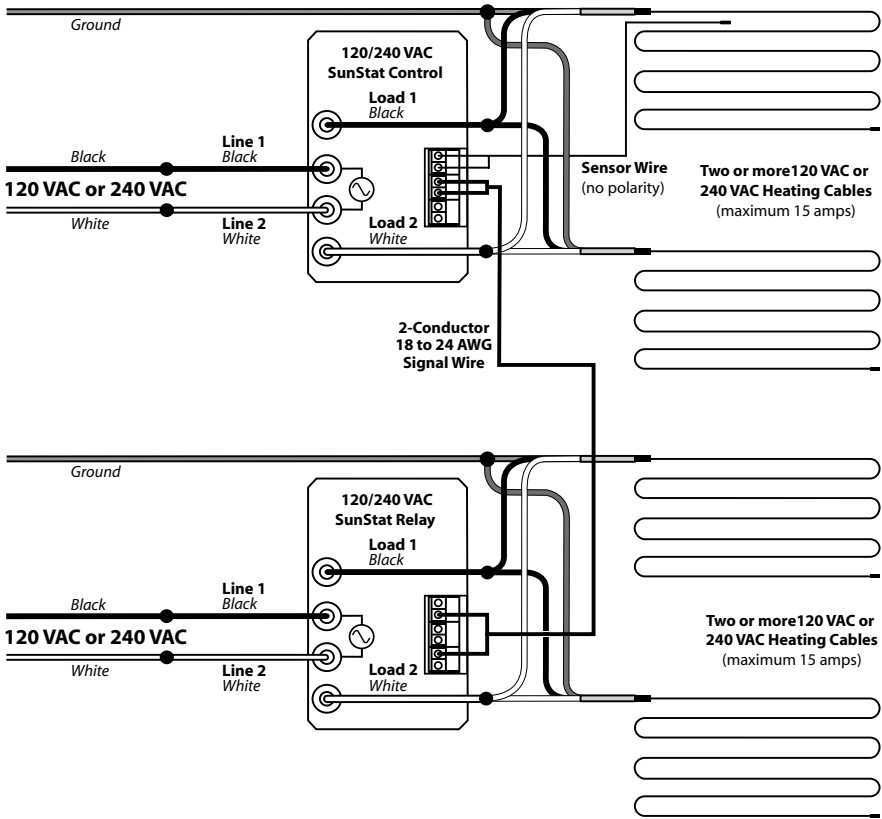
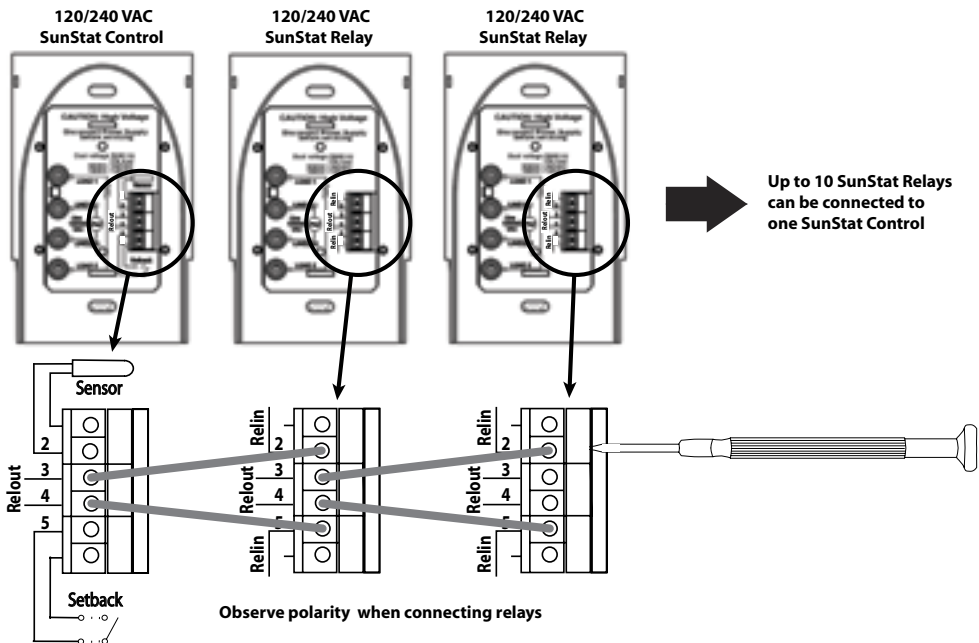

Diagram for connection of signal wire between SunStat Control and Relays



Appendix 3: Connecting Multiple Cables

NOTE: The control is not shown in these diagrams in order to simplify them. These diagrams are given only as examples of how to properly connect multiple cables. Care must be taken not to overfill a box. Be sure to use wire nuts that are the correct size for the connections being made. Follow all codes for wiring. If in doubt, consult an electrician.

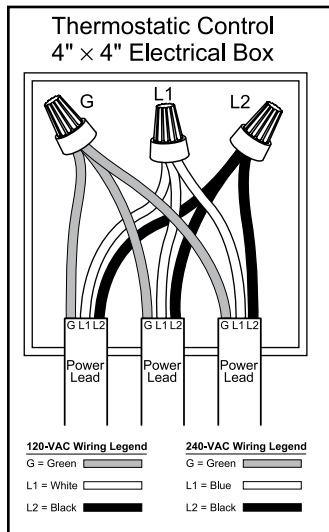

Illustration showing how to connect three cables at the control electrical box.

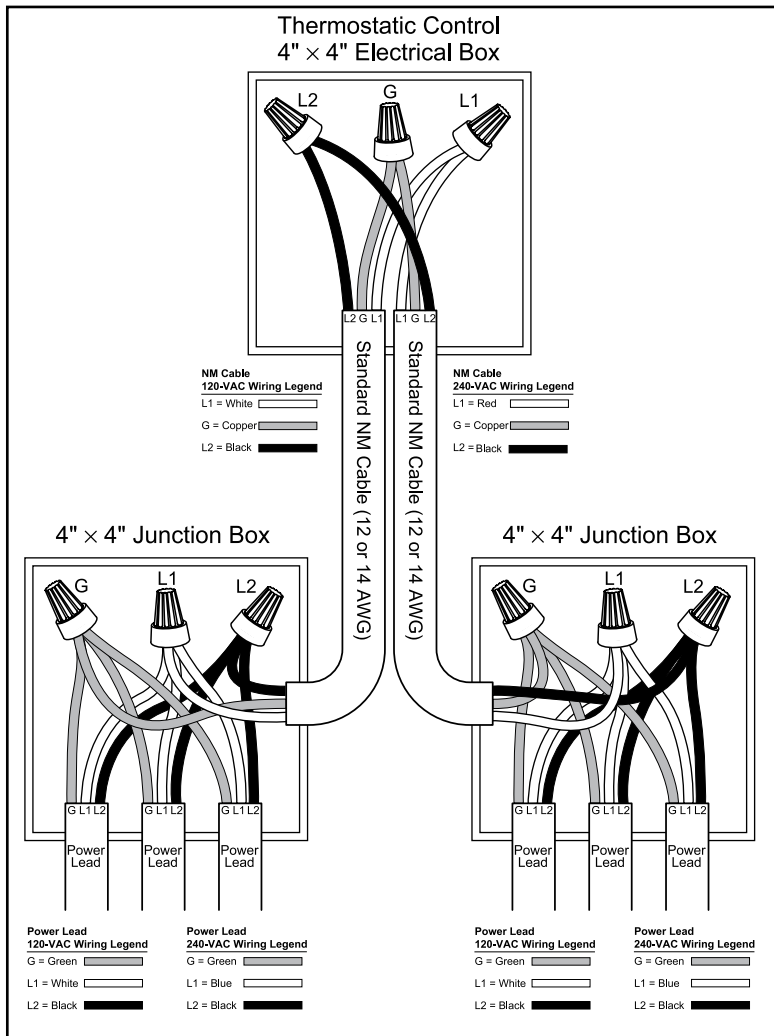
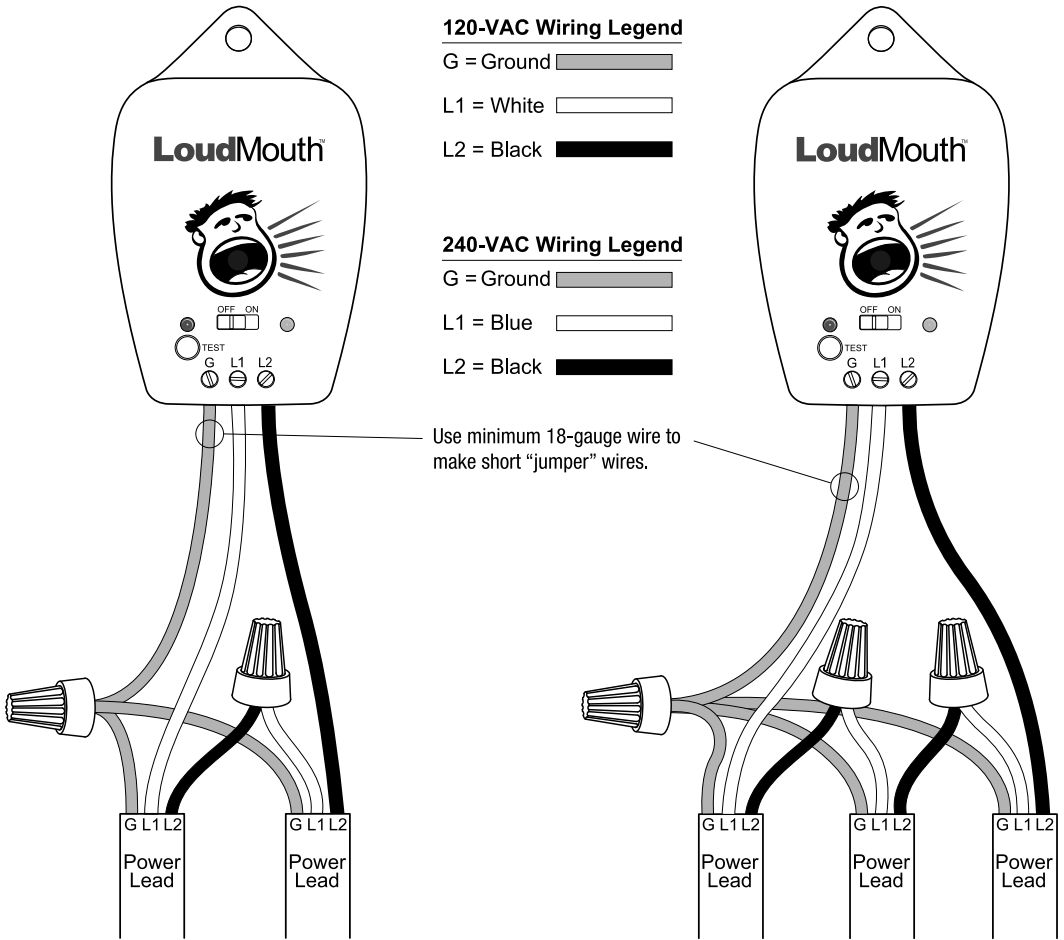

Illustration showing how to connect multiple cables from multiple junction boxes at one control electrical box.

Appendix 4: Connecting the LoudMouth Monitor



Illustrations showing (left) how to connect the LoudMouth monitor to two cables, and (right) how to connect the LoudMouth to three cables. The LoudMouth can monitor no more than three cables simultaneously. Do NOT leave the power leads connected in "series" like this when making final wiring connections; the cables will not heat sufficiently.

Appendix 5: Sample Layouts

Kitchen and Family Room (normal heat loss, slab on grade with insulation)

Two zones, 240 volts: Kitchen/Zone 1a = 1 spool; Zone 1b = 1 spool; 120 sq. ft., 2" spacing.

Family Room/Zone 2 = 1 spool, 240 sq. ft., 2 1/2" spacing

190 ft. of strap, or eight 25-ft. rolls.

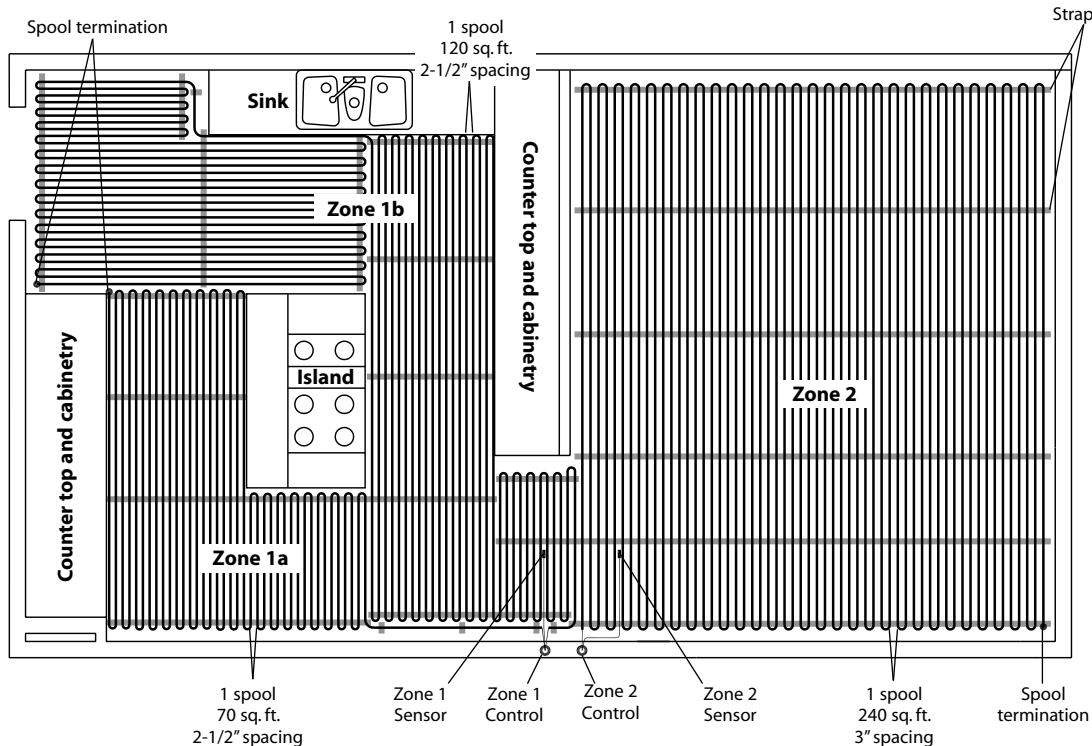

Kitchen and SunRoom (normal and high heat loss, framed floor construction)

One zone, 240 volts: Kitchen = 1 spool; 120 sq. ft.; 2-1/2" spacing.

Sunroom = 1 spool; 112 sq. ft.; 2" spacing.

104 ft. of strap, or five 25-ft. rolls.

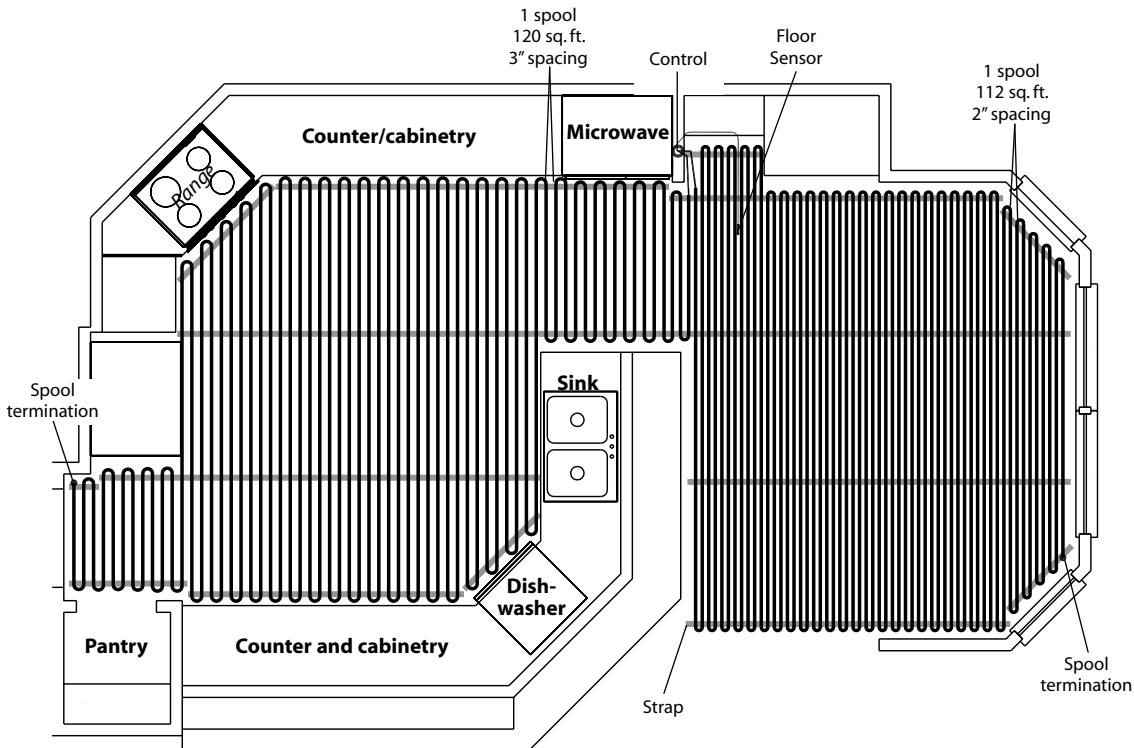

Master Bathroom (normal heat loss, framed floor construction)

One zone, 120 volts: 1 spool; 470 sq. ft.; 2-1/2" spacing. 35 ft. of strap, or two 25-ft. rolls.

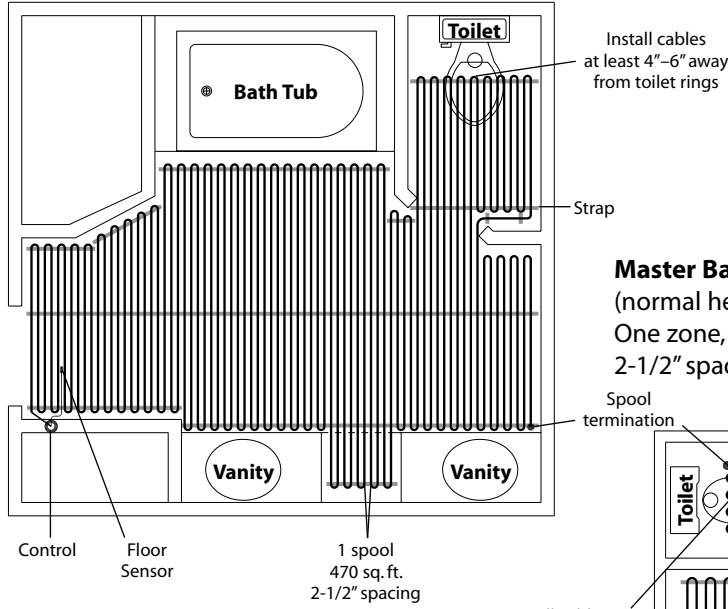

Master Bathroom

(normal heat loss, framed floor construction)

One zone, 120 volts: 1 spool; 80 sq. ft.;

2-1/2" spacing. 24 ft. of strap, or one 25-ft. roll.

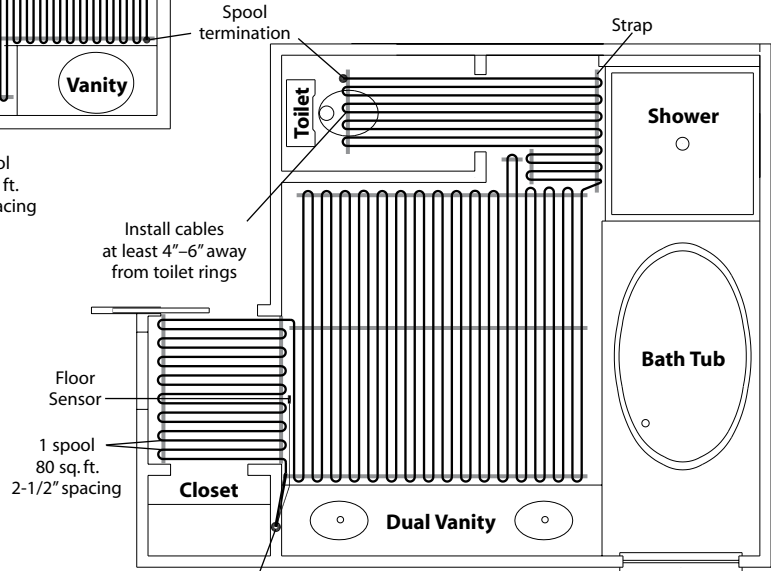

Master Bathroom

(normal heat loss, framed floor construction)

One zone, 120 volts: 1 spool; 90 sq. ft.;

2-1/2" spacing. 49 ft. of strap, or two 25-ft. rolls.

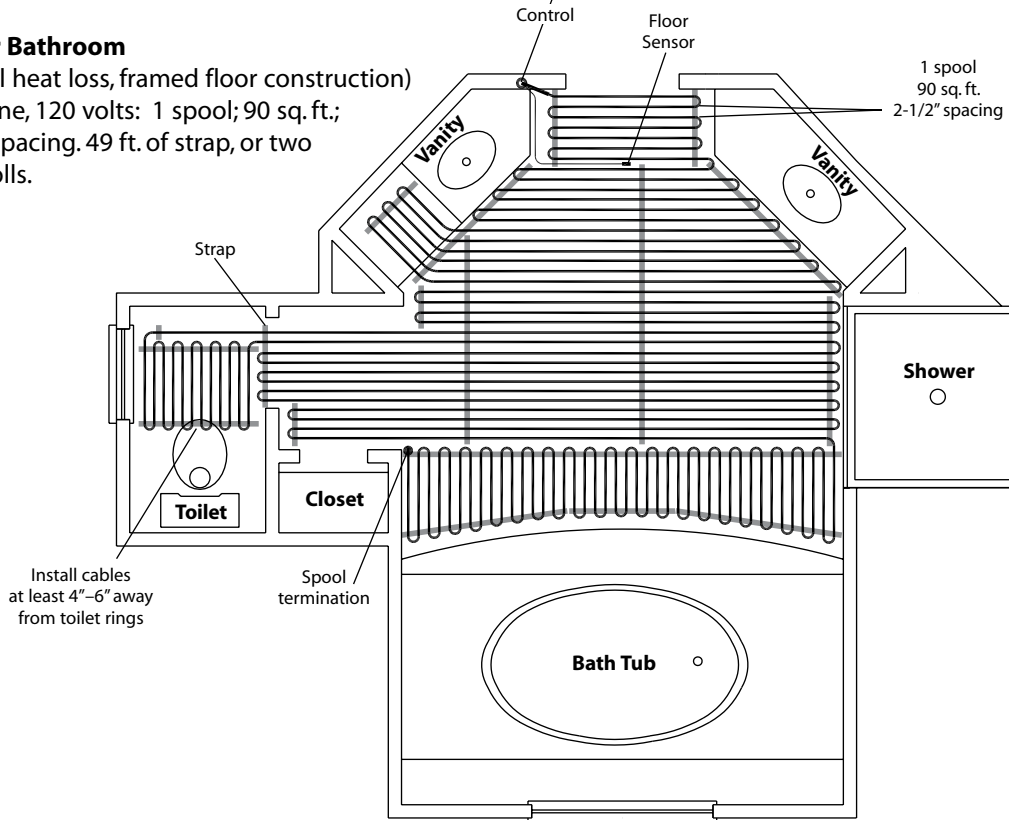

Basement Bathroom (high heat loss, below grade basement slab)

One zone, 120 volts: 1 spool; 60 sq. ft.; 2" spacing. 39 ft. of strap, or two 25-ft. rolls.

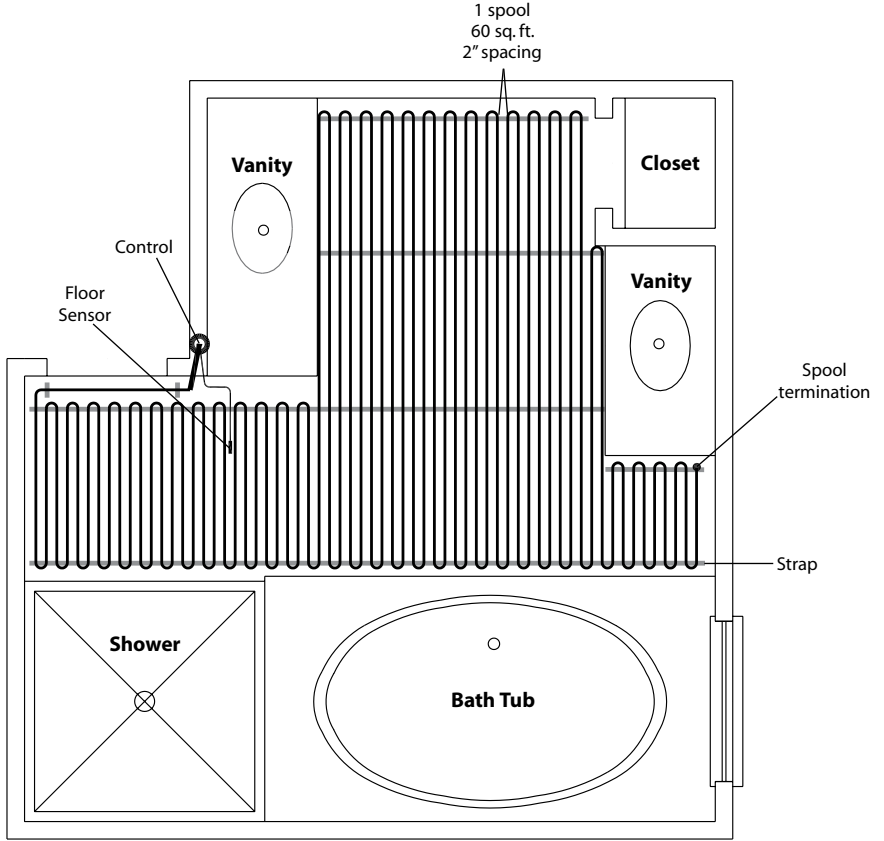

Master Bathroom (normal heat loss, framed floor construction)

One zone, 120 volts: 1 spool, 20 sq. ft., 2-1/2" spacing.

11 ft. of strap, or one 25-ft. roll.

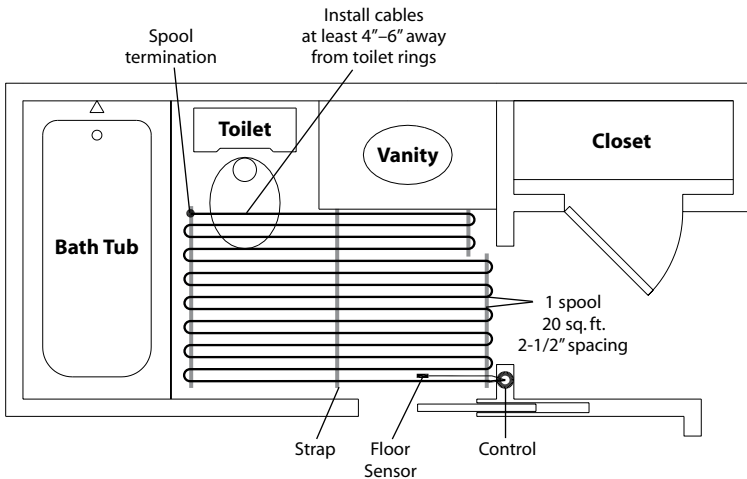

Master Bathroom (normal heat loss, framed floor construction)

One zone, 120 volts: 1 spool, 80 sq. ft., 2-1/2" spacing.

46 ft. of strap, or two 25-ft. rolls.

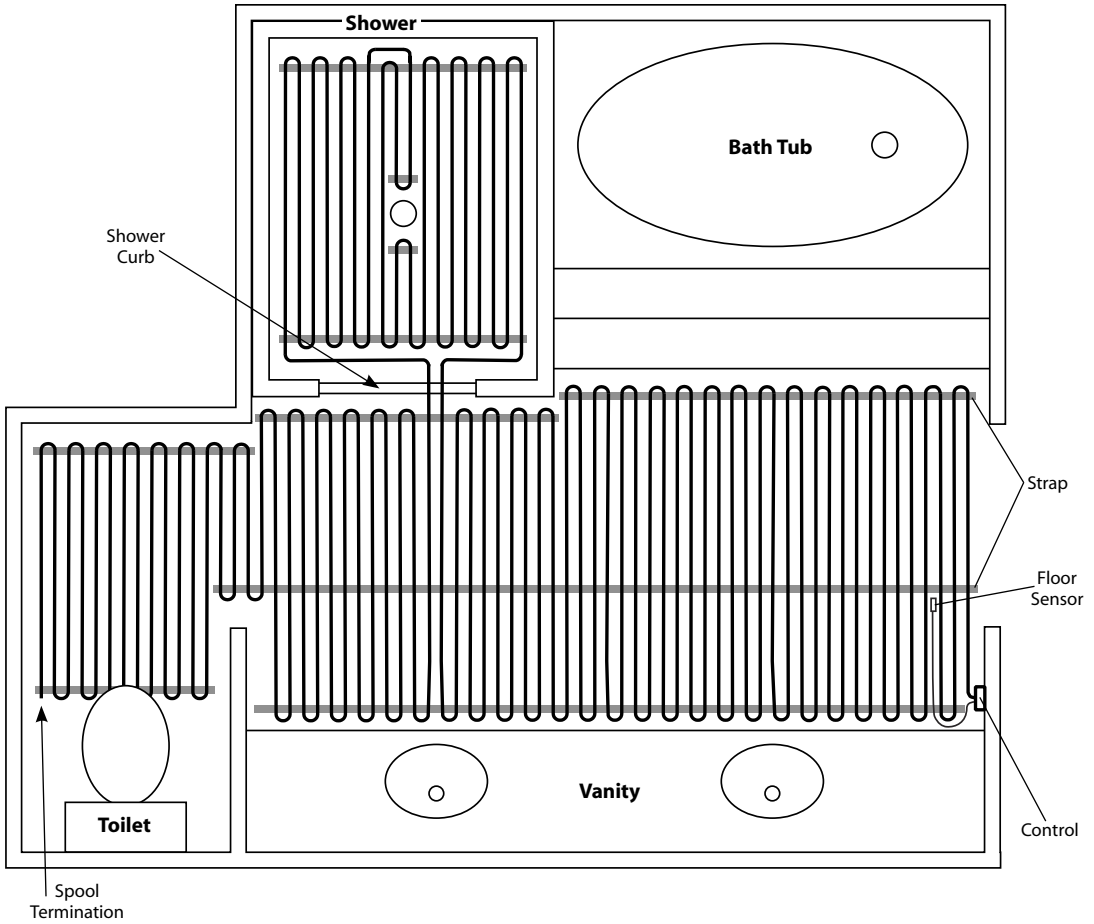

Detail of Shower Curb

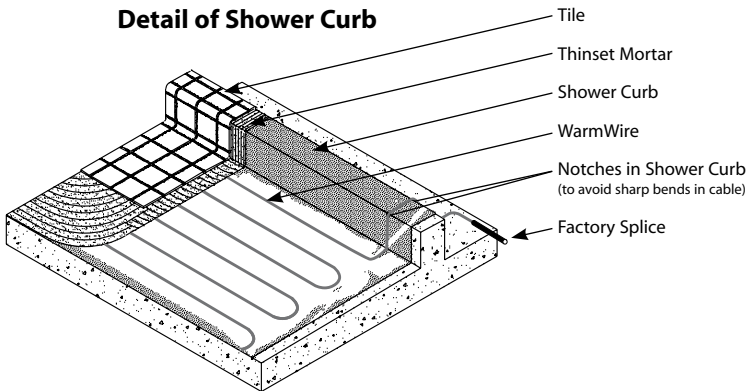

Recreation Room (high heat loss, below grade basement slab) One zone, 240 volts: 1 spool; 160 sq. ft.; 2" spacing. 69 ft. of strap, or three 25-ft. rolls.

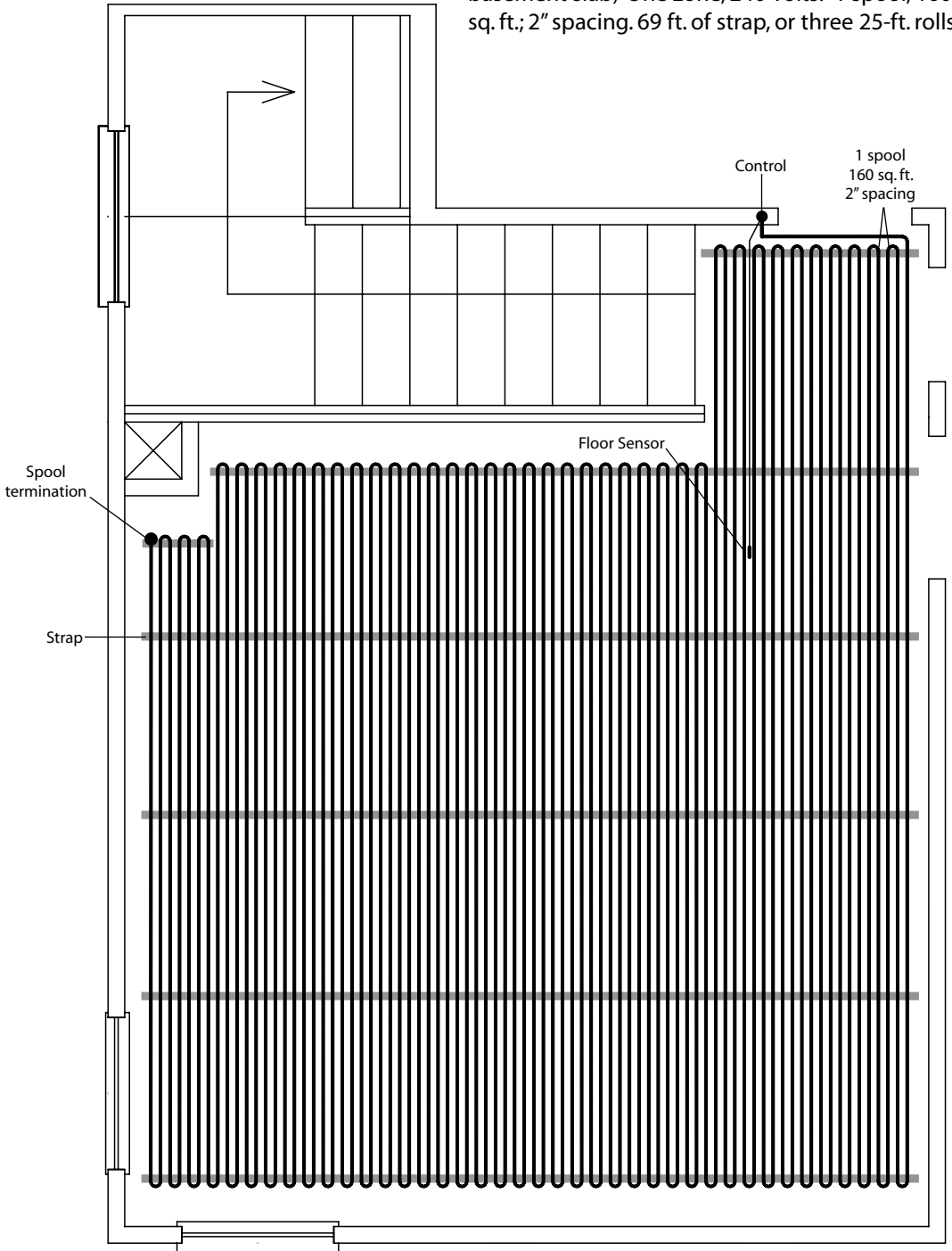



4500 E. Progress Place
Springfield, MO 65803-8816
888-432-8932 (toll-free USA/Canada)
417-522-6128 (phone)
417-831-4067 (fax)
www.suntouch.com

Copyright © 2011 Watts Radiant SunTouch WarmWire Installation Manual