

Instructions for Installing PM-DP

Remote control for PM-2B Snow Melt Sensor

The PM-DP provides direct remote operation for the PM-2B, PM-224, and PM-824 snow sensors. Users can monitor both the operating mode and the activation state of the sensor. Additional control features include setting automatic, manual, or standby operation.

⚠ WARNING: General Safety Instructions

1. **THIS UNIT SHOULD BE INSTALLED ONLY BY QUALIFIED PERSONNEL!**
2. Disconnect all power from the control, or any associated equipment, before opening the front cover plate.

Installation

Install the PM-DP remote switch in a single gang box. The PM-DP may be installed in a conventional single or multi-gang electrical enclosure. If installed in a multi-gang enclosure next to high voltage equipment, the PM-DP and its interconnecting cable must be isolated from high voltage wires and devices. Consult local electrical codes to determine the isolation method(s) required. The PM-DP can be installed up to 800 feet away from the snow sensor.

- Remove all power to the sensor and open the cover
- Plug the CS-1 Pigtail into the jack labeled J3 on the snow sensor circuit board.

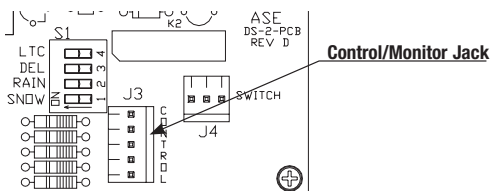

- Cut the required length of 5 or 6 conductor, minimum 22 AWG shielded cable.
- Prepare both ends of the conductor cable by removing 2 inches of outer jacket and shield, then strip 1/2" of the insulation from the conductors.
- Attach one end of the conductor cable to the free end of the CS-1 Pigtail inside a weatherproof junction box noting any color code change in the table.
- Following the color code table, attach the other end of this cable terminals 5 through 9 of the terminal block labeled TB1 on the PM-DP, making sure to connect the noted color to the proper terminal.
- Secure the wires to the TB1 connectors by pressing the clamp button on the terminal block and inserting the bare wire end and then releasing the button.
- Lightly tug on the wire to ensure the wire is securely connected.
- To reduce the chances of damage due to static shock, ground the PM-DP faceplate by removing 1 inch of insulation from the green EGND lead and connecting this lead along with the bare "drain" wire, in the long 5 or 6-conductor 22 AWG shielded cable, to an electrical ground lead using a wire nut or equivalent.

Home Automation

Use terminals 1-4 on TB1 when connecting to a home automation system. Closure of terminals 1-2 (Trigger) and 3-4 (Enable) will start one snow melting cycle. Once the cycle is completed the sensor will revert to Automatic mode.

Connect a toggle switch to the Enable terminals to allow manual enabling and disabling of the home automation system.

If a secondary toggle switch is not used, jumper terminals 3-4 to allow the home automation system to enable the system as needed.

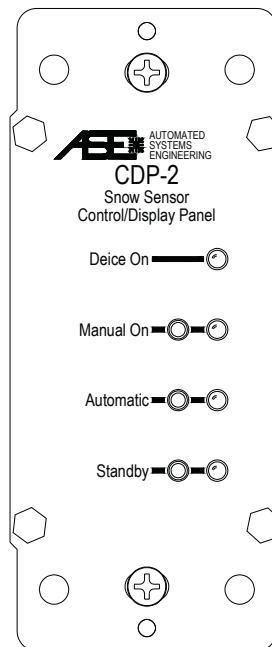
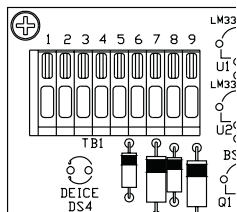

PM-DP fits directly into a single-gang box and can be fitted with a standard "modular" electrical cover plate. A CS-1 pigtail is included with the PM-DP.

Operation

The LED indicators reflect the current operating mode of the snow sensor and snow melting system. The LED's blink periodically rather than remaining steadily illuminated.

- The **Deice On** indicator shows whether or not the attached snow sensor has been activated and the snow melt system is operating. It may illuminate either from automatic activation of the sensor or by the user pressing the **Manual On** button.
- Pressing **Standby** will set the connected snow sensor to ignore snow fall and prohibit automatic operation of an attached snow melt system.
- Pressing **Automatic** will set the connected snow sensor to automatically activate and control an attached snow melt system when snow is detected.
- Pressing the **Manual On** button will not trigger the sensor to run continuously but will initiate one drying cycle. This function allows the user to run a cycle without having to remember to shut the system off. At the end of the drying cycle the system will revert to **Automatic** mode, ready for detection. The user may reset and clear the drying cycle by pressing **Standby**. Typically a drying cycle time is configured on the snow sensor with a delay of 30-90 minutes. It begins once snow stops falling and allows the heated surface to more thoroughly dry.

The PM-DP will display the current setting of the manual override switch for the attached snow sensor. The sensor's override switch will always take precedence over the PM-DP setting. For example, if the PM-DP has placed the sensor into Standby mode and the sensor switch is moved Manual On, the PM-DP will show the change to Manual On mode.

Whenever the sensor's switch overrides the PM-DP's setting, then is returned to Automatic Mode, the PM-DP will revert to the Automatic Mode as well.

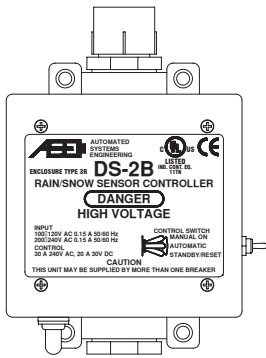

The PM DP snow melt sensor remote control is compatible with PM-2B, PM-224, and PM-824 snow controls. See submittal or installation instructions for more information.

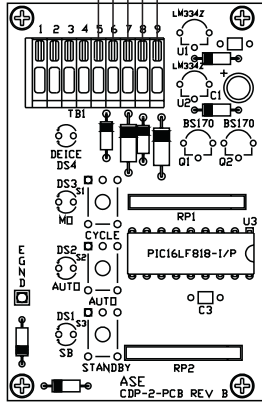
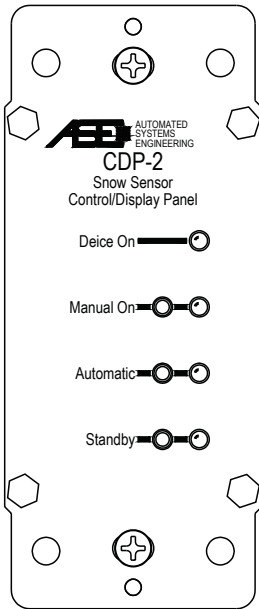
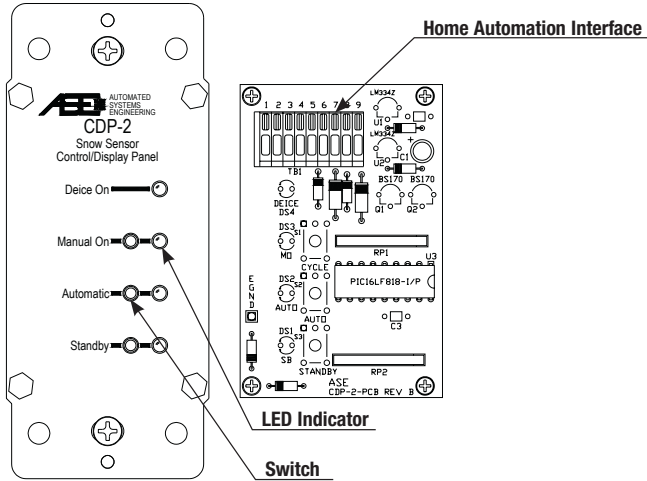

22 AWG Shielded 5 or 6 Conductor Cable

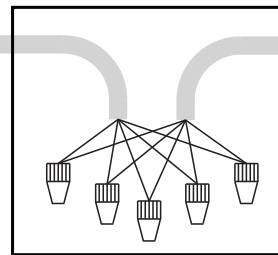
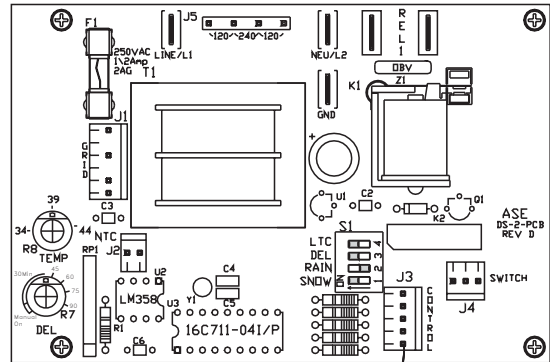

Waterproof Junction Box

Specifications	
Supply Voltage	Class 2 (Derived from Snow Sensor)
Compatible sensors	PM-2B PM-224 PM-824
Operating Temperature Range	-40°F to 185°F
Dry Cycle Time	Based on Sensor Setting
Location Used	Indoor
Wiring Type	22 AWG (minimum) 5 or 6 conductor
Maximum Distance	800 ft.

CS-1 Color	Function	Field Color	PM-DP Terminal
Black	Manual On		5
White	Return		6
Green	Standby/Reset		7
Orange	Deice On		8
Red	Deice On		9

Limited Warranty: Watts Radiant (the "Company") warrants each product to be free from defects in material and workmanship under normal usage for a period of one year from the date of original shipment. In the event of such defects within the warranty period, the Company will, at its option, replace or recondition the product without charge. **THE WARRANTY SET FORTH HEREIN IS GIVEN EXPRESSLY AND IS THE ONLY WARRANTY GIVEN BY THE COMPANY WITH RESPECT TO THE PRODUCT. THE COMPANY MAKES NO OTHER WARRANTIES, EXPRESS OR IMPLIED. THE COMPANY HEREBY SPECIFICALLY DISCLAIMS ALL OTHER WARRANTIES, EXPRESS OR IMPLIED, INCLUDING BUT NOT LIMITED TO THE IMPLIED WARRANTIES OF MERCHANTABILITY AND FITNESS FOR A PARTICULAR PURPOSE.** The remedy described in the first paragraph of this warranty shall constitute the sole and exclusive remedy for breach of warranty, and the Company shall not be responsible for any incidental, special or consequential damages, including without limitation, lost profits or the cost of repairing or replacing other property which is damaged if this product does not work properly, other costs resulting from labor charges, delays, vandalism, negligence, fouling caused by foreign material, damage from adverse water conditions, chemical, or any other circumstances over which the Company has no control. This warranty shall be invalidated by any abuse, misuse, misapplication, improper installation or improper maintenance or alteration of the product. Some States do not allow limitations on how long an implied warranty lasts, and some States do not allow the exclusion or limitation of incidental or consequential damages. Therefore the above limitations may not apply to you. This Limited Warranty gives you specific legal rights, and you may have other rights that vary from State to State. You should consult applicable state laws to determine your rights. **SO FAR AS IS CONSISTENT WITH APPLICABLE STATE LAW, ANY IMPLIED WARRANTIES THAT MAY NOT BE DISCLAIMED, INCLUDING THE IMPLIED WARRANTIES OF MERCHANTABILITY AND FITNESS FOR A PARTICULAR PURPOSE, ARE LIMITED IN DURATION TO ONE YEAR FROM THE DATE OF ORIGINAL SHIPMENT.**